



Eliminator

Motorcycle Owner's Manual

FOREWORD

We wish to thank you for choosing this fine Kawasaki Motorcycle. Your new motorcycle is the product of Kawasaki's advanced engineering, exhaustive testing, and continuous striving for superior reliability, safety, and performance.

Read this Owner's Manual before riding so you will be thoroughly familiar with the proper operation of your motorcycle's controls, its features, capabilities and limitations. This manual offers many safe riding tips, but its purpose is not to provide instruction in all the techniques and skills required to ride a motorcycle safely. Kawasaki strongly recommends that all operators of this vehicle enroll in a motorcycle rider training program to attain awareness of the mental and physical requirements necessary for safe motorcycle operation.

To ensure a long, trouble-free life for your motorcycle, give it the proper care and maintenance described in this manual. For those who would like more detailed information on their Kawasaki Motorcycle, a Service Manual is available for purchase from any Kawasaki Dealer. The Service Manual contains detailed disassembly and maintenance information.

Due to improvements in design and performance during production, in some cases there may be minor discrepancies between the actual vehicle and the illustrations and text in this manual.

KAWASAKI HEAVY INDUSTRIES, LTD.
MOTORCYCLE GROUP

////////////////////// TABLE OF CONTENTS ////////////////////////

<p>Specifications 8</p> <p>Consumer Information 11</p> <p>Location of Parts 12</p> <p>Location of Labels 15</p> <p>Loading Information 17</p> <p>General Information 20</p> <p style="padding-left: 20px;">Meter Instruments 20</p> <p style="padding-left: 40px;">Speedometer and Tachometer 21</p> <p style="padding-left: 40px;">Indicator Lights 21</p> <p style="padding-left: 40px;">Key 22</p> <p style="padding-left: 20px;">Ignition Switch/ Steering Lock 23</p> <p style="padding-left: 20px;">Right Handlebar Switches 24</p> <p style="padding-left: 40px;">Engine Stop Switch 24</p> <p style="padding-left: 40px;">Starter Button 25</p> <p style="padding-left: 20px;">Left Handlebar Switches 25</p> <p style="padding-left: 40px;">Dimmer Switch 25</p> <p style="padding-left: 40px;">Turn Signal Switch 26</p> <p style="padding-left: 40px;">Horn Button 26</p> <p style="padding-left: 40px;">Hazard Switch 26</p> <p style="padding-left: 20px;">Fuel Tank Cap 27</p>	<p>Fuel Tank 27</p> <p>Fuel Tap 29</p> <p>Stand 30</p> <p>Document/Tool Kit/Chain Lock Container 31</p> <p>Tool Kit 32</p> <p>Chain Lock 32</p> <p>Air Cleaner Intake 33</p> <p>Seat Lock 33</p> <p>Helmet Hooks 34</p> <p>Break-In 35</p> <p>How to Ride the Motorcycle 36</p> <p style="padding-left: 20px;">Starting the Engine 36</p> <p style="padding-left: 20px;">Jump Starting 38</p> <p style="padding-left: 20px;">Moving Off 40</p> <p style="padding-left: 20px;">Shifting Gears 41</p> <p style="padding-left: 20px;">Braking 43</p> <p style="padding-left: 20px;">Stopping the Engine 44</p> <p style="padding-left: 20px;">Stopping the Motorcycle in an Emergency 45</p> <p style="padding-left: 20px;">Parking 46</p>
--	---

Safe Operation	47	Brake Light Switches	87
Safe Riding Technique	47	Front Fork	88
Daily Safety Checks	49	Rear Shock Absorbers	89
Additional Considerations for		Wheels	93
High Speed Operation	51	Battery	97
Maintenance and Adjustment	53	Headlight Beam	101
Periodic Maintenance Chart	54	Fuses	103
Engine Oil	57	Fuel System	104
Cooling System	61	General Lubrication	106
Final Gear Case Oil	69	Bolt and Nut Tightening	108
Spark Plugs	71	Cleaning	110
Valve Clearance	73	Storage	112
Kawasaki Clean Air System	74	Troubleshooting Guide	114
Evaporative Emission		Maintenance Record	115
Control System	75		
Air Cleaner	76		
Throttle Grip	78		
Choke Lever	80		
Carburetors	82		
Clutch	83		
Brakes	84		

//////////////////////////////////// SPECIFICATIONS //////////////////////////////////////

PERFORMANCE

Minimum Turning Radius	3.0 m (118.1 in)
Braking Distance	12.5 m from 50 km/h (41 ft from 31 mph)

DIMENSIONS

Overall Length	2 240 mm (88.19 in)
Overall Width	810 mm (31.9 in)
Overall Height	1 075 mm (42.32 in)
Wheelbase	1 595 mm (62.80 in)
Road Clearance	145 mm (5.71 in)
Dry Weight	2 330 N (238 kg, 525 lb)

ENGINE

Type	DOHC, 16-valve, 4-cylinder, 4-stroke, liquid-cooled
Displacement	908 mL (55.4 cu in)
Bore x Stroke	72.5 x 55.0 mm (2.85 x 2.17 in)
Compression Ratio	11.0 : 1
Starting System	Electric Starter
Cylinder Numbering Method	Left to right, 1-2-3-4
Firing Order	1-2-4-3
Carburetor	Keihin CVK32 x 4
Ignition System	Battery and coil (transistorized ignition)
Ignition Timing	10° BTDC @1 000 (Ca) 1 200) r/min (rpm) –
(Electronically advanced)	35° BTDC @3 500 r/min (rpm)

Spark Plugs

NGK D8EA or ND X24ES-U

Lubrication System

© NGK DR8ES-L or ND X24ESR-U

Engine Oil

Forced lubrication (wet sump)

Engine Oil Capacity

SE or SF class SAE 10W40, 10W50, 20W40, or 20W50

Coolant Capacity

3.7 L (3.9 US qt)

3.1 L (3.3 US qt)

TRANSMISSION

Transmission Type

6-speed, constant mesh, return shift

Clutch Type

Wet, multi disc

Driving System

Shaft drive

Primary Reduction Ratio

1.732 (97/56)

Final Reduction Ratio

2.994 (16/19 x 32/9)

Overall Drive Ratio

5.371 (Top gear)

Gear Ratio: 1st

2.800 (42/15)

2nd

2.000 (38/19)

3rd

1.590 (35/22)

4th

1.333 (32/24)

5th

1.153 (30/26)

6th

1.035 (29/28)

Final Gear Case Oil

API GL-5 SAE 90 [above 5°C (41°F)]

SAE 80 [below 5°C (41°F)]

Final Gear Case Oil Capacity

220 mL (0.23 US qt)

FRAME

Castor	29°
Trail	102 mm (4.02 in)
Tire Size: Front	100/90-18 56H
Rear	160/80-15 74H
Fuel Tank Capacity	11 L (2.9 US gal)

ELECTRICAL EQUIPMENT

Battery	12 V 14 AH
Headlight	12 V 60/55 W
Tail/Brake Light	12 V 8/27 W x 2

© : Canadian model

Cal : Californian model

Specifications subject to change without notice.

CONSUMER INFORMATION

Vehicle Minimum Stopping Distance on Dry Pavement

These figures indicate braking performance that can be met or exceeded by the vehicle to which they apply, without locking the wheels, under different conditions of loading. The information presented represents results obtainable by skilled drivers under controlled road and vehicle conditions, and the information may not be correct under other conditions.

Description of vehicle to which this table applies: Model ZL900-A1

A. Fully Operational Service Brake

Load:

Light

Maximum

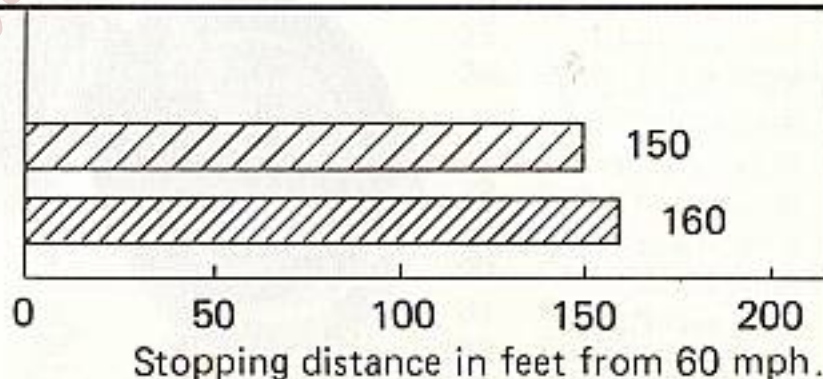

Manufacturer: Kawasaki Heavy Industries, Ltd.

LOCATION OF PARTS

1. Front Fork
2. Headlight
3. Turn Signal/Running Position Light
4. Radiator Cap
5. Air Suction Valve Cover
6. Fuel Tap
7. Idle Adjusting Screw
8. Air Cleaner Element
9. Junction Box
10. Document/Tool Kit/Chain Lock Container
11. Rear Shock Absorber
12. Helmet Hook
13. Turn Signal Light
14. Brake Disc
15. Brake Caliper
16. Radiator
17. Side Stand Switch
18. Shift Pedal
19. Oil Level Gauge
20. Side Stand
21. Muffler
22. Final Gear Case

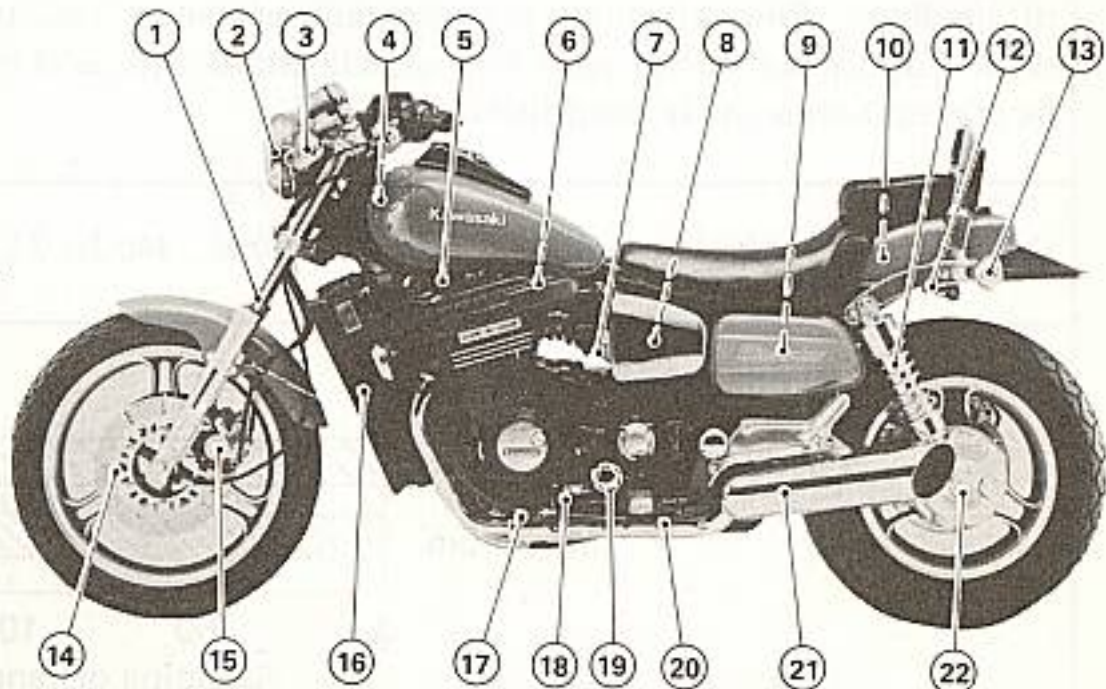

LOCATION OF LABELS

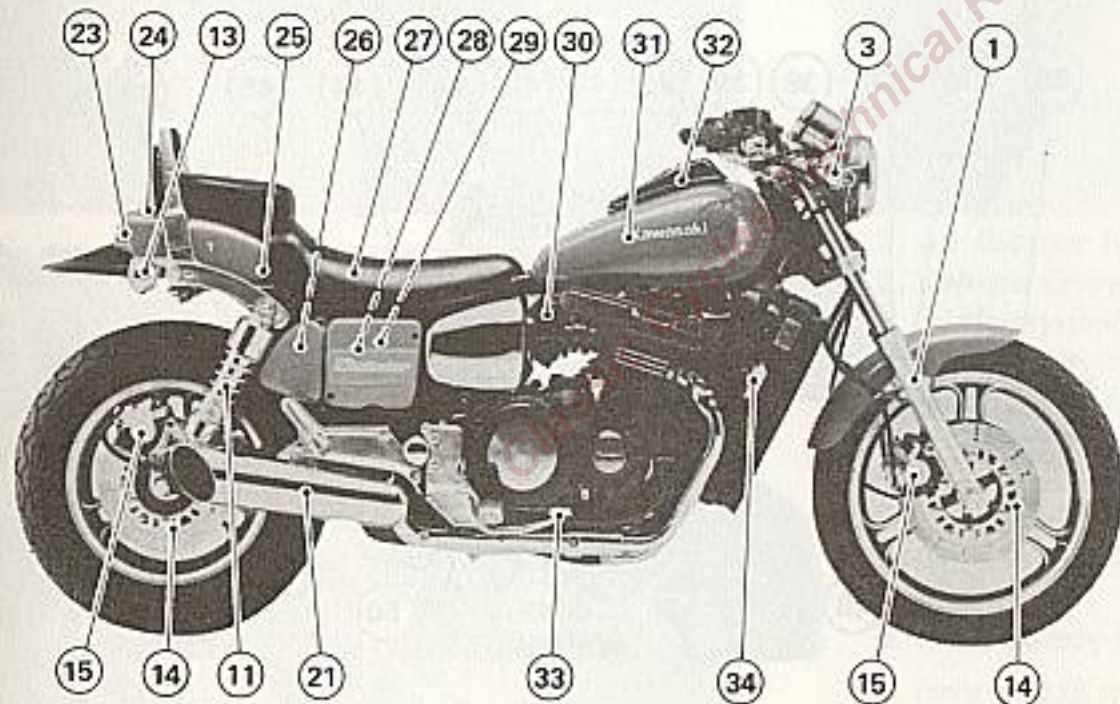

- 23. Tail/Brake Light
- 24. License Plate Light
- 25. Seat Lock
- 26. Brake Fluid Reservoir (Rear)
- 27. Seat
- 28. Battery
- 29. Coolant Reserve Tank
- 30. Carburetor
- 31. Fuel Tank
- 32. Fuel Tank Cap
- 33. Rear Brake Pedal
- 34. Horn

- 35. Clutch Lever
- 36. Dimmer Switch
- 37. Hazard Switch
- 38. Choke Lever
- 39. Starter Lockout Switch
- 40. Clutch Fluid Reservoir
- 41. Speedometer
- 42. Indicator Lights
- 43. Tachometer
- 44. Brake Fluid Reservoir (Front)
- 45. Engine Stop Switch
- 46. Front Brake Lever
- 47. Horn Button
- 48. Turn Signal Switch
- 49. Ignition Switch/Steering Lock
- 50. Starter Button
- 51. Throttle Grip

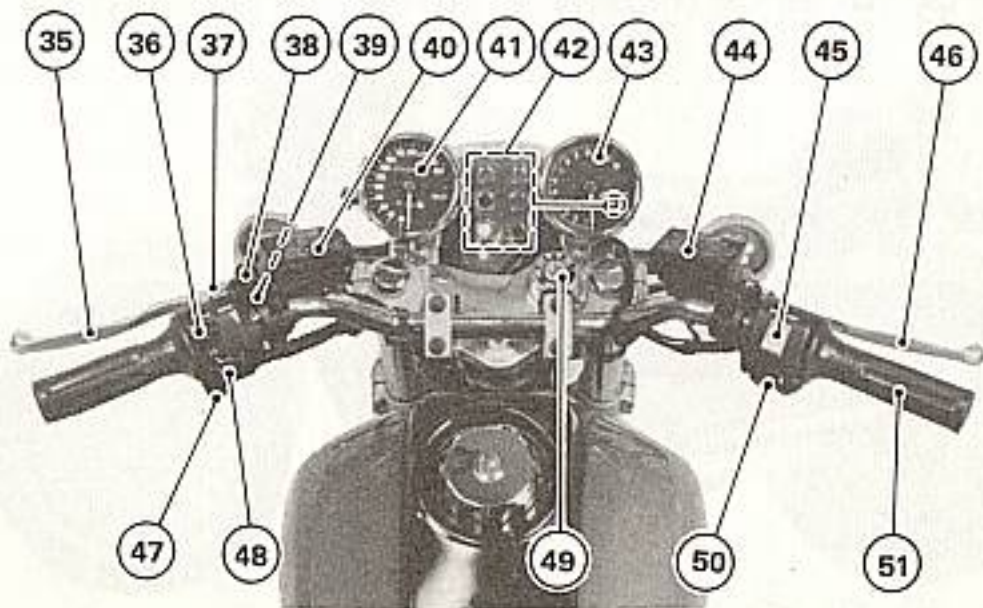

LOCATION OF LABELS

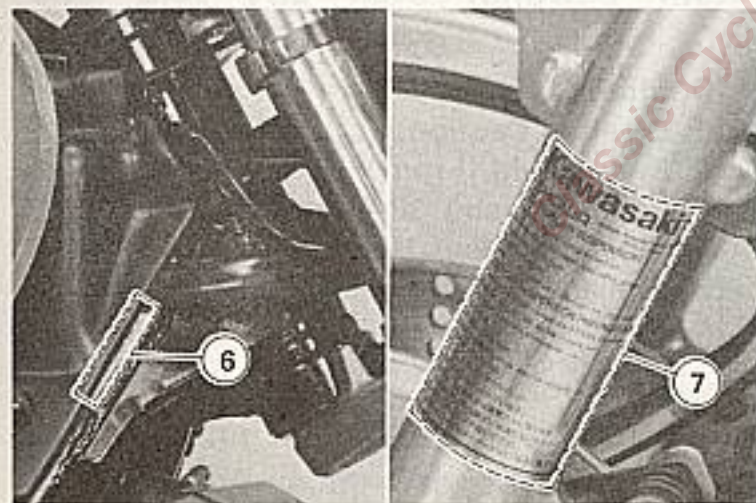
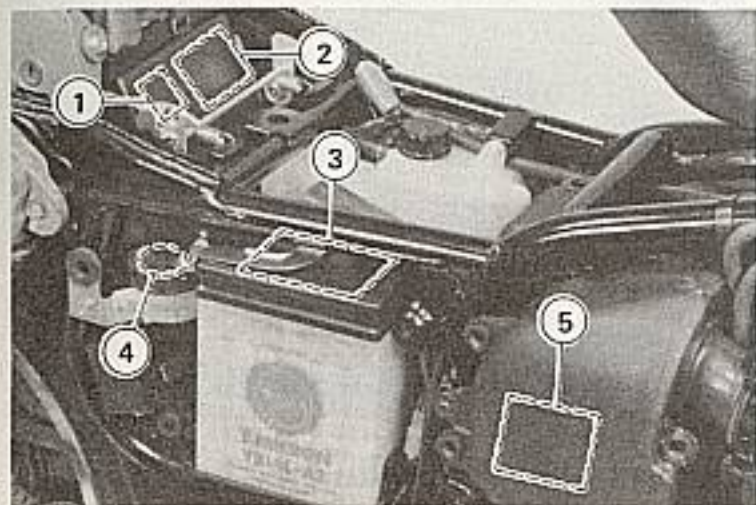

1. Air Cleaner Intake
 - *2. Vehicle Emission Control Information
 3. Battery Vent Hose
 4. Brake Fluid (Rear)
 - **5. Vacuum Hose Routing Diagram
 - *6. Noise Emission Control Information
 7. Air Suspension (Front Fork)
 - **8. Fuel Level
 9. Daily Safety Checks
- * only on US model
** only on Californian model

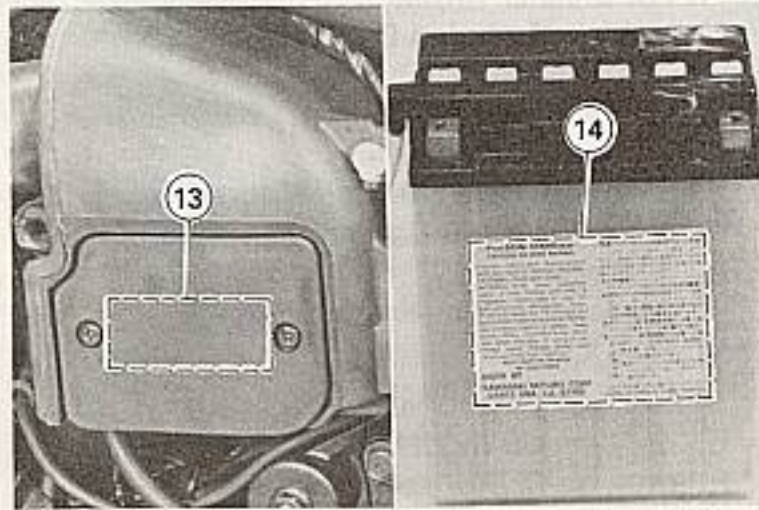
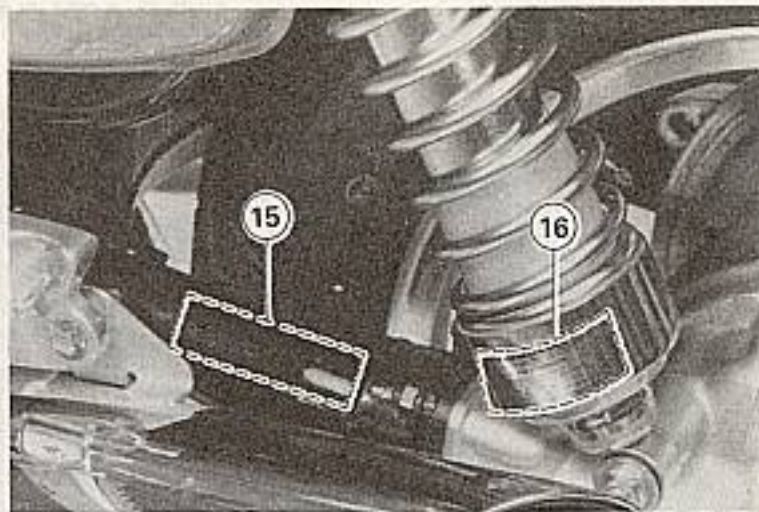
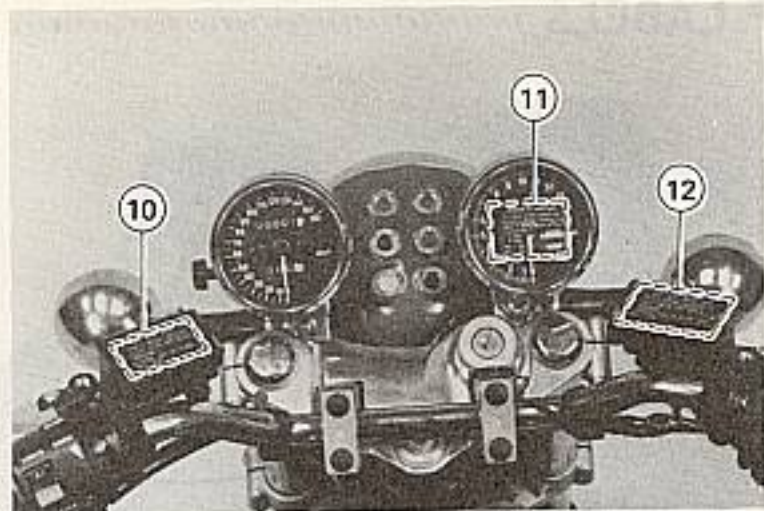

- 10. Clutch Fluid
- *11. Break-In Caution
- 12. Brake Fluid (Front)
- 13. Engine Oil and Oil Filter
- 14. Battery Poison/Danger
- 15. Tire and Load Data
- 16. Air Suspension
(Rear Shock Absorber)

* only on US model

LOADING INFORMATION

WARNING

○ **Incorrect loading, improper installation or use of accessories, or modification of your motorcycle may result in an unsafe riding condition. Before you ride the motorcycle, make sure that the motorcycle, is not overloaded (refer to page 94 for maximum load information) and that you have followed these instructions.**

With the exception of genuine Kawasaki Parts and Accessories, Kawasaki has no control over the design or application of accessories. In some cases, improper installation or use of accessories, or motorcycle modification, will void the motorcycle warranty. In selecting and using accessories, and in

loading the motorcycle, you are personally responsible for your own safety and the safety of other persons involved.

NOTE

○ *Kawasaki Parts and Accessories have been specially designed for use on Kawasaki motorcycles. We strongly recommend that all parts and accessories you add to your motorcycle be genuine Kawasaki components.*

Because a motorcycle is sensitive to changes in weight and aerodynamic forces, you must take extreme care in carrying cargo, passengers and/or in the fitting of additional accessories. The following general guidelines have been prepared to assist you in making your determinations.

1. Any passenger should be thoroughly familiar with motorcycle operation. The passenger can affect control of the motorcycle by improper positioning during cornering and sudden movements. It is important that the passenger sit still while the motorcycle is in motion and not interfere with the operation of the motorcycle. Do not carry animals on your motorcycle.
2. You should instruct any passenger before riding to keep his feet on the passenger footpegs and hold on to the operator, seat strap, or grab rail. Do not carry a passenger unless he or she is tall enough to reach the footpegs and footpegs are provided.
3. All baggage should be carried as low as possible to reduce the effect on the motorcycle center of gravity. Baggage weight should also be distributed equally on both sides of the motorcycle. Avoid carrying baggage that extends beyond the rear of the motorcycle. Do not carry animals on your motorcycle.
4. Baggage should be securely attached. Make sure that the baggage will not move around while you are riding. Recheck baggage security as often as possible (not while the motorcycle is in motion) and adjust as necessary.
5. Do not carry heavy or bulky items on a luggage rack. They are designed for light items, and overloading can affect handling due to changes in weight distribution and aerodynamic forces.
6. Do not install accessories or carry baggage that impairs the performance of the motorcycle. Make sure that you have not adversely affected any

lighting component, road clearance, banking capability (i.e., lean angle), control operation, wheel travel, front fork movement, or any other aspect of the motorcycle's operation.

7. Weight attached to the handlebar or front fork will increase the mass of the steering assembly and can result in an unsafe riding condition.

8. Fairings, windshields, backrests, and other large items have the capability of adversely affecting stability and handling of the motorcycle, not only because of their weight, but also due to the aerodynamic forces acting on these surfaces while the motorcycle is in operation. Poorly designed or installed items can result in an unsafe riding condition.

9. This motorcycle was not intended to be equipped with a sidecar or to be used to tow any trailer or other vehicle. Kawasaki does not manufacture sidecars or trailers and cannot predict the effects of such accessories on handling or stability, but can only warn that the effects can be adverse and that Kawasaki cannot assume responsibility for the results of such unintended use of the motorcycle. Furthermore, any adverse effects on motorcycle components caused by the use of such accessories will not be remedied under warranty.

GENERAL INFORMATION

Meter Instruments

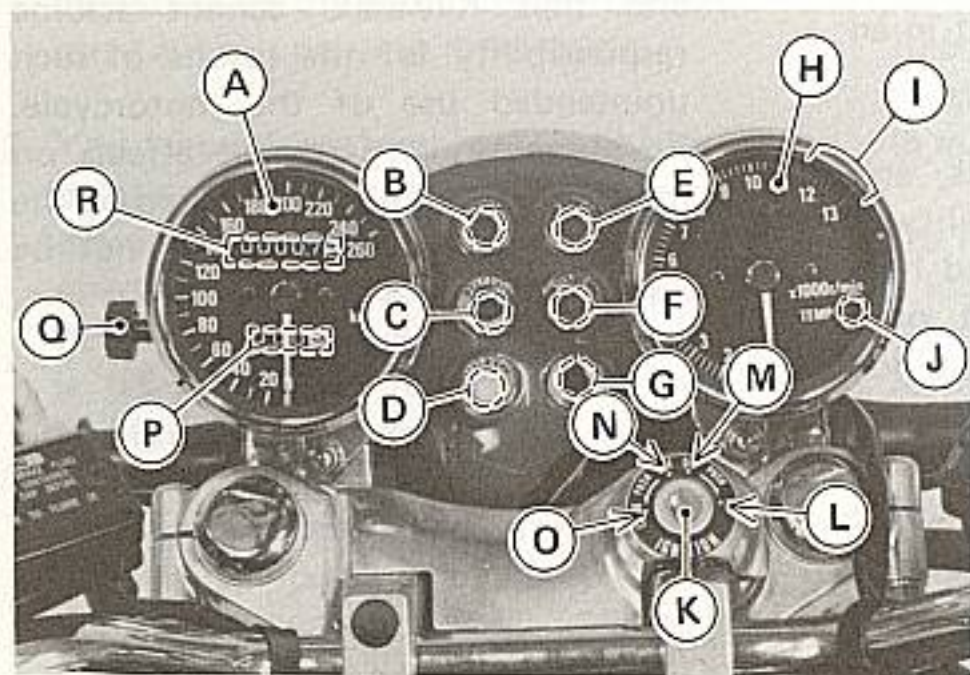

- A. Speedometer
- B. Left Turn Signal Indicator Light
- C. Neutral Indicator Light
- D. Headlight Failure Indicator Light
- E. Right Turn Signal Indicator Light
- F. High Beam Indicator Light
- G. Oil Pressure Warning Light
- H. Tachometer
- I. Red Zone
- J. Coolant Temperature Warning Light
- K. Ignition Switch/Steering Lock
- L. P(Park) position
- M. ON position
- N. OFF position
- O. LOCK position
- P. Trip Meter
- Q. Reset Knob
- R. Odometer

Speedometer and Tachometer

The speedometer shows the speed of the vehicle. In the speedometer face are the odometer and trip meter. The odometer shows the total distance that the vehicle has been ridden. The trip meter shows the distance traveled since it was last reset to zero. The trip meter can be reset to zero by turning the reset knob counterclockwise.

The tachometer shows the engine speed in the revolutions per minute (r/min, rpm). On the right side of the tachometer face is a portion called the "red zone". Engine r/min (rpm) in the red zone is above maximum recommended engine speed and is also above the range for good performance.

CAUTION

○ Engine r/min (rpm) should not be allowed to enter the red zone; operation

in the red zone will overstress the engine and may cause serious engine damage.

Indicator Lights

TURN: When the turn signal switch is turned to left or right, the corresponding turn signal indicator light flashes on and off.

NEUTRAL: When the transmission is in neutral, the neutral indicator light is lit.

HEAD LAMP: If either the high or low beam burns out, the reserve lighting system switches over to the remaining filament automatically, and lights the headlight failure indicator light to show that the headlight bulb must be replaced.

HIGH BEAM:When the headlight is on high beam, the high beam indicator light is lit.

OIL:The oil pressure warning light goes on whenever the oil pressure is dangerously low or the ignition switch is in the ON position with the engine not running. It goes off when the engine oil pressure is high enough. Refer to the Maintenance and Adjustment chapter for more detailed engine oil information.

TEMP:The coolant temperature warning light (LED-Light Emitting Diode) goes on when the ignition switch is turned on and goes off soon after the engine starts running to ensure that its circuit functions properly. The warning light also goes on whenever the coolant temperature rises to 120°C or higher

when the motorcycle is in operation. If it stays on, stop the engine and check the coolant level in the reserve tank after the engine cools down.

CAUTION

○Do not let the engine continue running when the warning light goes on. Prolonged engine operation will result in severe damage from overheating.

Key

This motorcycle has a combination key, which is used for the ignition switch, steering lock, fuel tank cap, seat lock, and helmet hook.

Blank keys are available at your Kawasaki Dealers. Ask your Dealer to make any additional spare keys you may need, using your original key as a master.

Ignition Switch/Steering Lock

This is a four-position, key-operated switch. The key can be removed from the switch when it is in the OFF, LOCK, or P(PARK) position.

OFF	Engine off. All electrical circuits off.
ON	Engine on. All electrical equipment can be used.
LOCK	Steering locked. Engine off. All electrical circuits off.
P (PARK)	Steering locked. Engine off. Taillight and license plate light on. Turn signal circuit on. All other electrical circuits cut off.

NOTE

- The tail, running position, and license plate lights are on whenever the ignition switch is in the ON position. The headlight goes on when the starter button is released after starting the engine. To avoid battery discharge, always start the engine immediately after turning the ignition switch to ON.
- If you leave the PARK position on for a long time (one hour), the battery may become totally discharged.

To operate the ignition switch:

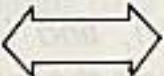
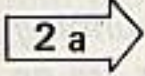
OFF  ON  P(PARK)

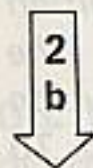

LOCK

1. Turn the handlebar fully to the left.
2. a. For parking push down the key in the ON position and turn it to P (Park).
b. For locking push down the key in the OFF position and turn it to LOCK.

Right Handlebar Switches Engine Stop Switch

In addition to the ignition switch, the engine stop switch must be in the RUN position for the motorcycle to operate.

The engine stop switch is for emergency use. If some emergency requires stopping the engine, move the engine stop switch to the OFF position.

NOTE

○Although the engine stop switch stops the engine, it does not turn off all the electrical circuits. Ordinarily, the ignition switch should be used to stop the engine.

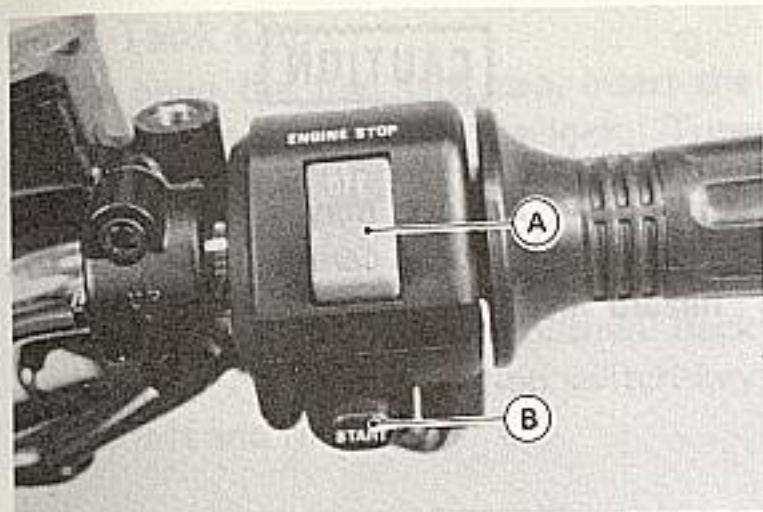

Left Handlebar Switches

Dimmer Switch

High or low beam can be selected with the dimmer switch. When the headlight is on high beam (HI), the high beam indicator light is lit.



A. Engine Stop Switch B. Starter Button

Starter Button

The starter button operates the electric starter when pushed with the clutch lever pulled in or the transmission in neutral.



Refer to the Starting the Engine section of the "How to Ride the Motorcycle" chapter to start the engine.

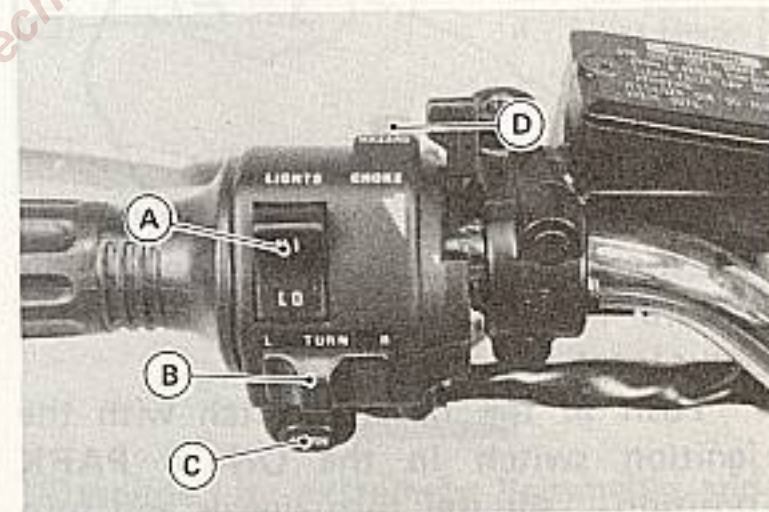

A. Dimmer Switch C. Horn Button
B. Turn Signal Switch D. Hazard Switch

CAUTION

Turn Signal Switch

When the turn signal switch is turned to L (left) or R (right), the corresponding turn signals flash on and off.

Horn Button

When the horn button is pushed, the horn sounds.

Hazard Switch

If an emergency requires you to park on the highway shoulder, turn on the hazard lights to warn other drivers of your location.

Push in the hazard switch with the ignition switch in the ON or PARK position. All the turn signals and turn signal indicator lights will flash on and off.

- If you leave the switch on for a long time, the battery may become totally discharged. So be careful not to use the hazard lights for more than 30 minutes.

Fuel Tank Cap

To open the fuel tank cap, insert the ignition switch key into the lock. Turn the key to the right, then turn the lock grip to the left. The tank cap is unlocked and can be opened. The tank cap automatically locks when pushed back into place. Turn the ignition switch key to the left and remove it.

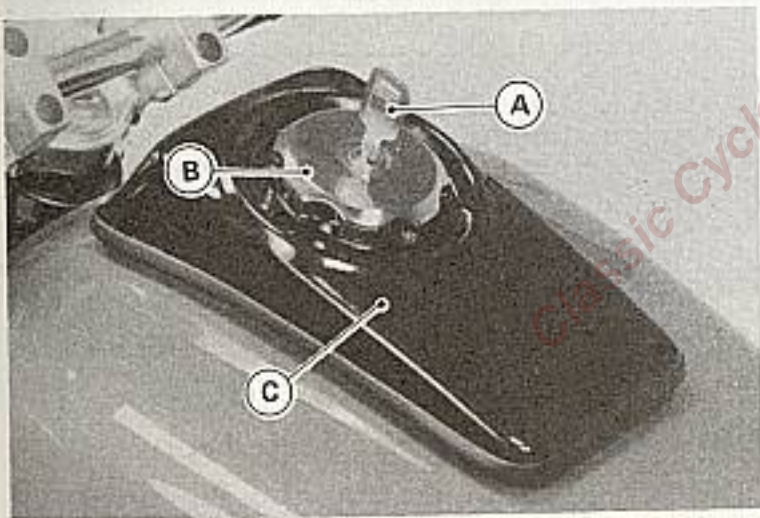

A. Ignition Switch Key C. Fuel Tank Cap
B. Lock Grip

Fuel Tank

The following octane rating gasoline is recommended in the fuel tank. Avoid filling the tank in the rain or where heavy dust is blowing so that the fuel does not get contaminated.

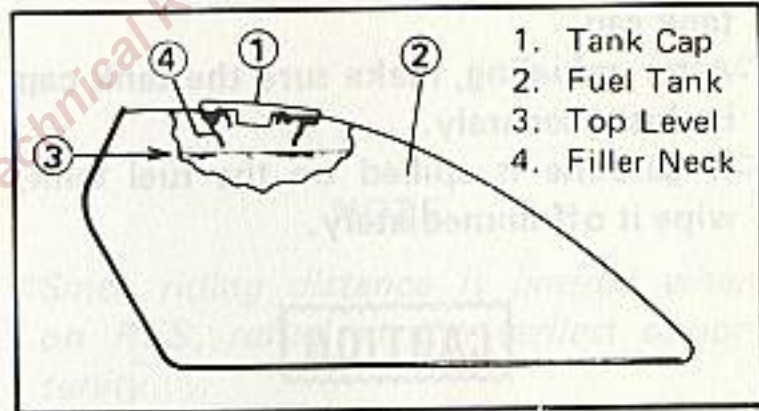

WARNING

Gasoline is extremely flammable and can be explosive under certain conditions. Turn the ignition switch OFF.

Do not smoke. Make sure the area is well ventilated and free from any source of flame or sparks; this includes any appliance with a pilot light.

- Never fill the tank so the fuel level rises into the filler neck. If the tank is overfilled, heat may cause the fuel to expand and overflow through the vents in the tank cap.
- After refueling, make sure the tank cap is closed securely.
- If gasoline is spilled on the fuel tank, wipe it off immediately.

CAUTION

- California models only: Never fill the tank so the fuel level rises into the filler neck. If the tank is overfilled, heat may cause the fuel to expand and flow into the Evaporative Emission Control System resulting in hard starting and engine hesitation.

Fuel Requirement:

Octane Rating

The octane rating of a gasoline is a measure of its resistance to detonation or "knocking". Use a gasoline with an octane rating equal to or higher than that shown in the table below.

Octane Rating Method	Minimum Rating
Antiknock Index $\frac{(\text{RON} + \text{MON})}{2}$	87
Research Octane No. (RON)	91

The Antiknock Index is an average of the Research Octane No. (RON) and the Motor Octane No. (MON). The Antiknock Index is posted on service station pumps in the U.S.A. Research Octane No. is a commonly used term describing a gasoline's octane rating.

Fuel Tap

The fuel tap is an automatic type which shuts off the fuel supply when the engine is stopped in the ON or RES position.

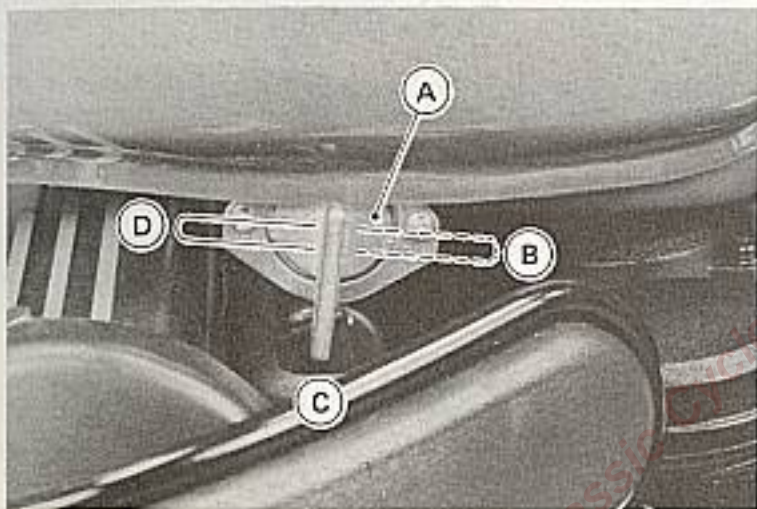

A. Fuel Tap
B. ON position

C. PRI position
D. RES position

The fuel tap has three positions: ON, RES (reserve), and PRI (prime). If the fuel runs out with the tap in the ON position, turn the tap to PRI, leave it for a

few seconds, and then turn it to RES. The last 3.9 L (1.03 US gal) of fuel can be used by turning the fuel tap to RES.

The PRI position bypasses the automatic control and is useful for priming the engine after running out of gas, or for completely draining the tank.

NOTE

- *Since riding distance is limited when on RES, refuel at the earliest opportunity.*
- *Make certain that the fuel tap is turned to ON (Not RES) after filling up the fuel tank.*
- *To start a cold engine after the motorcycle has been stored for a long time, first turn the tap to PRI, leave it for a moment, and return it to ON.*

WARNING

- Practice operating the fuel tap with the motorcycle stopped. To prevent an accident you should be able to operate the fuel tap while riding without taking your eyes off the road.
- Be careful not to touch the hot engine while operating the fuel tap.
- Do not leave the fuel tap in the PRI (prime) position while riding or parking the motorcycle. The engine may become flooded or fuel may spill onto the ground and create a fire hazard, if the vehicle falls over.

Stand

The motorcycle is equipped with a side stand.

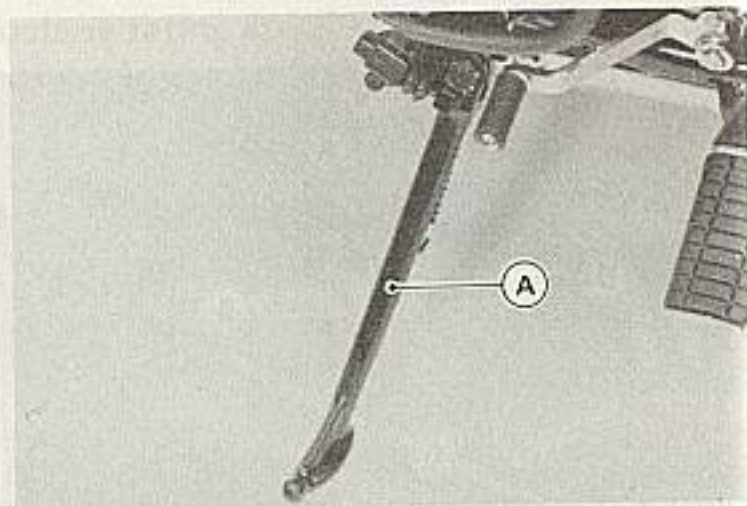

A. Side Stand

NOTE

- When using the side stand, turn the handlebar to the left.

Whenever the side stand is used, make it a practice to kick the stand fully up before sitting on the motorcycle.

WARNING

○ Forgetting and leaving the side stand down and riding away could cause an accident.

Document/Tool Kit/ Chain Lock Container

Use this container to keep the owner's manual and any papers or documents which should be kept with the motorcycle. Also store the tool kit and the chain lock in this container.



A. Tool Kit

Tool Kit

The tool kit is stored in the container. The minor adjustments and replacement of parts explained in this manual can be performed with the tool kit.

Chain Lock

The chain lock is stored in the container. Route the chain through the wheel and around the front forks or the rear shock absorbers, then lock it to prevent the wheel from rotating for anti-theft protection when parking.

WARNING

- Do not ride the motorcycle with the chain installed. Forgetting and starting could cause an accident.

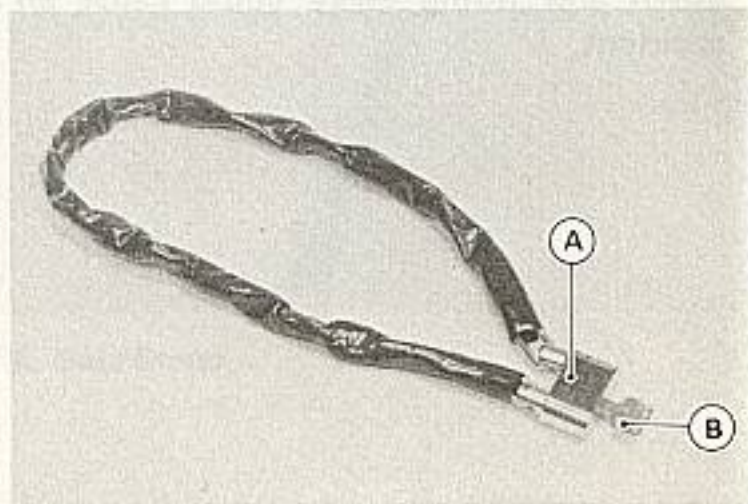

A. Chain Lock B. Key

Air Cleaner Intake

The air cleaner intake allows air to enter the engine. Never allow anything to restrict the flow of air into the air cleaner. A restricted air cleaner will reduce performance and increase exhaust emissions.

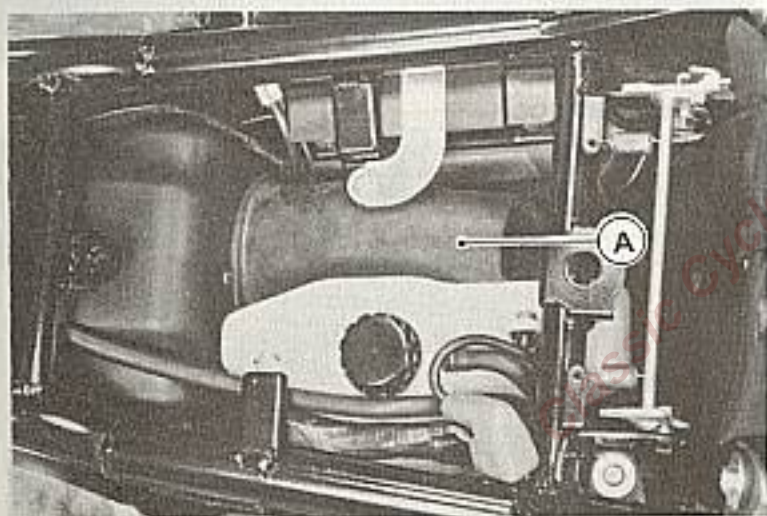

A. Air Cleaner Intake

Seat Lock

To open the seat, insert the ignition switch key into the seat lock, turn the key to the right, and swing open the seat. Use the seat stand on the seat back.

The seat is locked when pushed back into place.

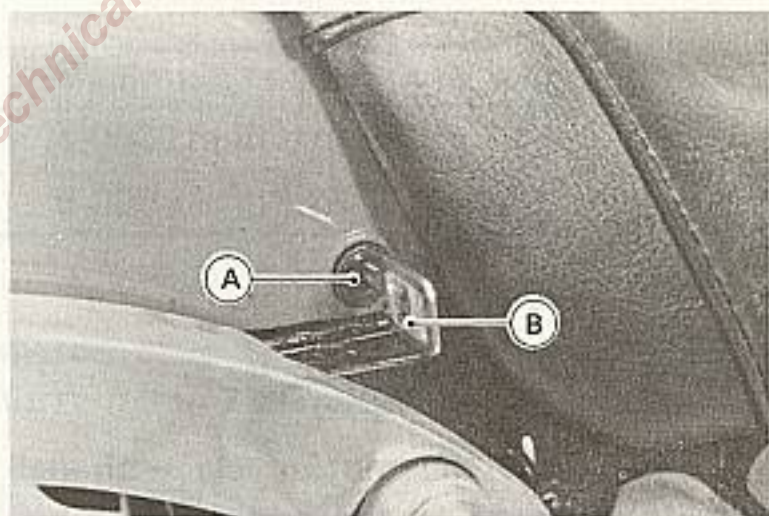

A. Seat Lock

B. Ignition Switch Key

Helmet Hooks

Helmets can be secured to the motorcycle using the helmet hooks. The helmet hook can be unlocked by inserting the ignition switch key into the lock, and turning the key to the right.

WARNING

- Do not ride the motorcycle with helmets attached to the hooks. The helmets could cause an accident by distracting the operator or interfering with normal vehicle operation.



A. Helmet Hook



A. Helmet Hook

////////////////////// BREAKING IN ////////////////////////

The first 1,600 km (1,000 mi) that the motorcycle is ridden is designated as the break-in period. If the motorcycle is not used carefully during this period, you may very well end up with a "broken down" instead of a "broken in" motorcycle after a few thousand kilometers.

The following rules should be observed during the break-in period.

- The table shows maximum recommended engine speed during the break-in period.

Distance traveled	Maximum engine speed
0 ~ 800 km (0 ~ 500 mi)	4,000 r/min (rpm)
800 ~ 1,600 km (500 ~ 1,000 mi)	6,000 r/min (rpm)

- Do not start moving or race the engine immediately after starting it, even if the engine is already warm. Run the engine for two or three minutes at idle speed to give the oil a chance to work up into all the engine parts.
- Do not race the engine while the transmission is in neutral.

In addition to the above, at 800 km (500 mi) it is extremely important that the owner have the initial maintenance service performed by a competent mechanic following the procedures in the Service Manual.

//////////////////// HOW TO RIDE THE MOTORCYCLE //////////////////////

Starting the Engine

- Check that the engine stop switch is in the RUN position.
- Turn the ignition switch on.
- Make certain the transmission is in neutral or the clutch is disengaged.

- If the engine is cold, pull the choke lever all the way.

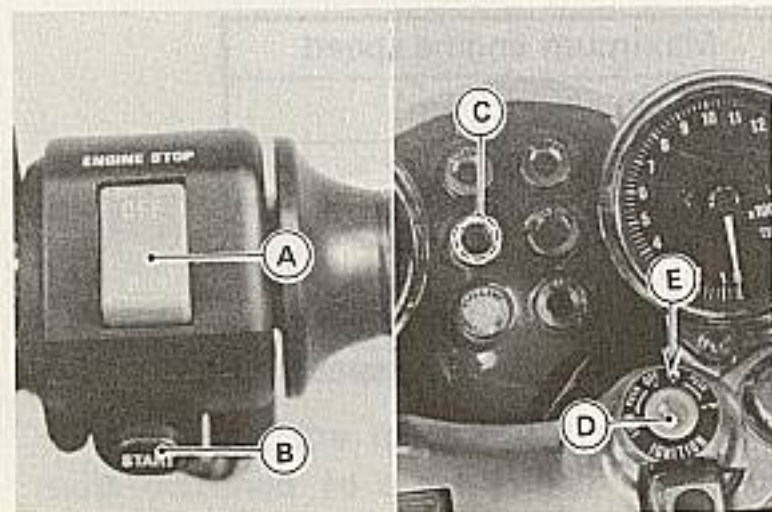

- A. Engine Stop Switch
- B. Starter Button
- C. Neutral Indicator Light
- D. Ignition Switch
- E. ON position

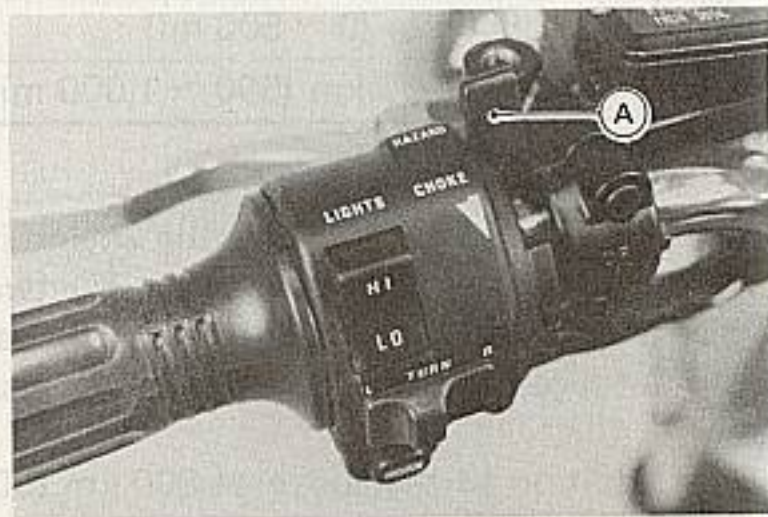

- A. Choke Lever

NOTE

○When the engine is already warm or on hot days [higher than 35°C (95°F)], open the throttle part way instead of using the choke, and then start the engine.

●Leaving the throttle completely closed, push the starter button with the clutch lever pulled in until the engine starts.

CAUTION

○Do not operate the starter continuously for more than 5 seconds or the starter will overheat and the battery power will drop temporarily. Wait 15 seconds between each operation of the starter to let it cool and the battery power recover.

NOTE

- If the engine is flooded, crank the engine over with the throttle fully open until the engine starts.
- The motorcycle is equipped with a starter lockout switch. This switch prevents the electric starter from operating when the clutch is engaged and the transmission is not in neutral.

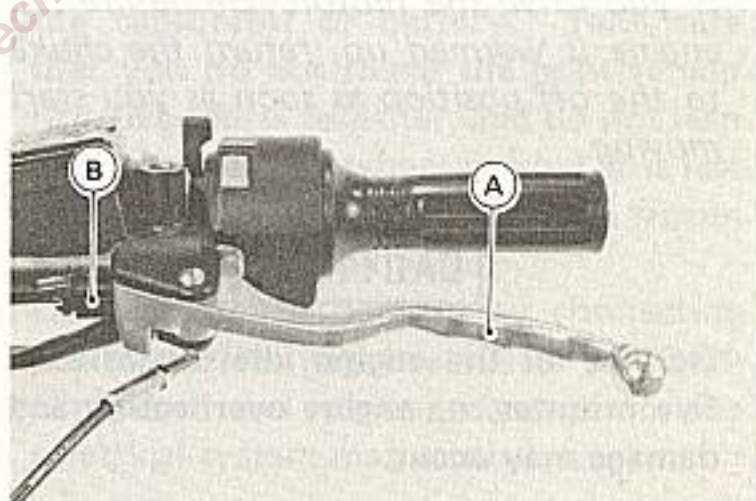

A. Clutch Lever
B. Starter Lockout Switch

- Gradually return the choke toward the off position a little at a time as necessary to keep the engine speed below 2,500 r/min (rpm) during warm-up.
- When the engine is warmed up enough to idle without using the choke, return the choke to the off position.

NOTE

○ If you drive the motorcycle before the engine is warmed up, return the choke to the off position as soon as you start moving.

CAUTION

- Do not let the engine idle longer than five minutes, or engine overheating and damage may occur.

Jump Starting

If your motorcycle battery is “run down,” it should be removed and charged. If this is not practical, a 12 volt booster battery and jumper cables may be used to start the engine.

WARNING

- Battery acid generates hydrogen gas which is flammable and explosive under certain conditions. It is present within a battery at all times, even in a discharged condition. Keep all flames and sparks (cigarettes) away from the battery. Wear eye protection when working with a battery. In the event of battery acid contact with skin, eyes, or clothing, wash the affected areas immediately with water for at least five minutes. Seek medical attention.

Connecting Jumper Cables

- Make sure the ignition switch is turned "OFF".
- Connect a jumper cable from the positive (+) terminal of the booster battery to the positive (+) battery cable at the starter relay terminal.

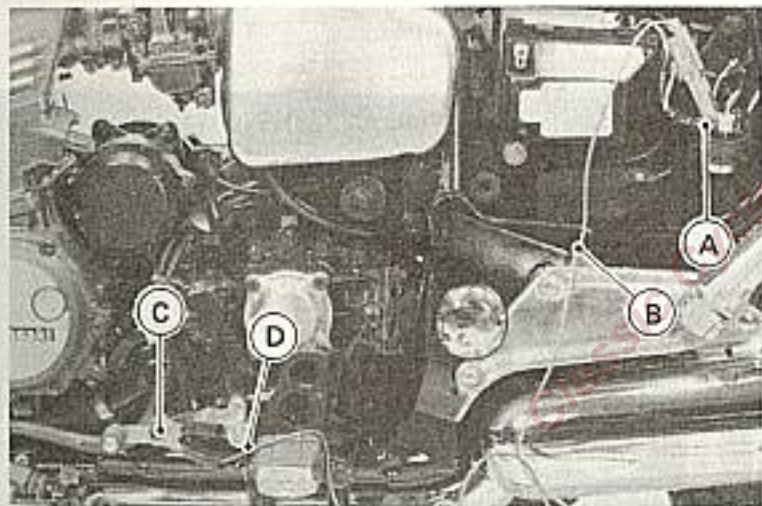

- A. Positive (+) Starter Relay Terminal
- B. To Booster Battery Positive (+) Terminal
- C. Unpainted Metal Surface
- D. To Booster Battery Negative (-) Terminal

- Connect another jumper cable from the negative (-) terminal of the booster battery to your motorcycle rear brake pedal or other unpainted metal surface. Do not use the negative (-) terminal of the battery.

WARNING

- Do not make this last connection at the carburetor or battery. Take care that you do not touch the positive and negative cables together, and do not lean over the battery when making this last connection. Do not jump start a frozen battery. It could explode.
 - Do not reverse polarity by connecting positive (+) to negative (-) or a battery explosion and serious damage to the electrical system may occur.
- Follow the standard engine starting procedure.

CAUTION

○Do not operate the starter continuously for more than 5 seconds or the starter will overheat and the battery power will drop temporarily. Wait 15 seconds between each operation of the starter to let it cool and the battery power recover.

●After the engine starts, disconnect the jumper cables. Disconnect the positive (+) cable from the motorcycle first.

Moving Off

- Check that the side stand is up.
- Pull in the clutch lever.
- Shift into 1st gear.
- Open the throttle a little, and start to let out the clutch lever very slowly.
- As the clutch starts to engage, open the throttle a little more, giving the engine just enough fuel to keep it from stalling.

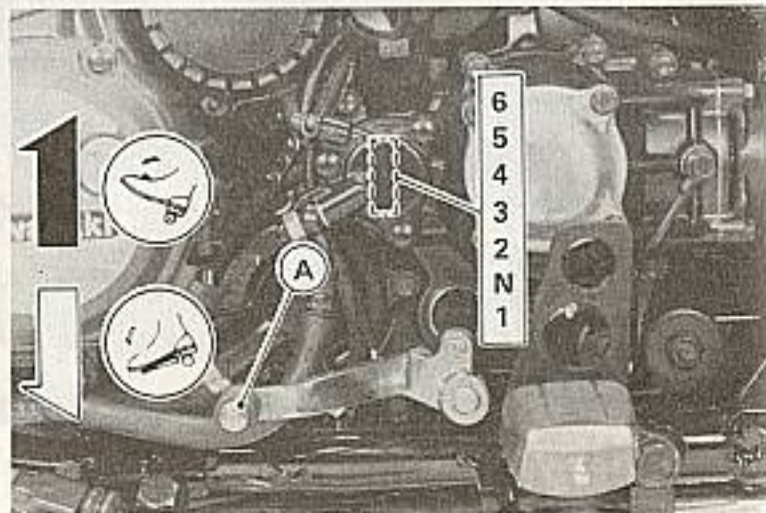

A. Shift Pedal

NOTE

○The motorcycle is equipped with a side stand switch. This switch is designed so that the engine stops if the clutch is engaged with the transmission in gear when the side stand has been left down.

Shifting Gears

- Close the throttle while pulling in the clutch lever.
- Shift into the next higher or lower gear. For smooth riding, shift up or down when the motorcycle is operated at the speeds shown in the table below.

WARNING

- When shifting down to a lower gear, do not shift at such a high speed that the engine r/min (rpm) jumps excessively. Not only can this cause engine damage, but the rear wheel may skid and cause an accident. Downshifting should be done below 5,000 r/min (rpm) for each gear.
- Open the throttle part way, while releasing the clutch lever.

NOTE

○The transmission is equipped with an automatic neutral finder. When the motorcycle is standing still, the transmission cannot be shifted past neutral from 1st gear. To use the automatic neutral finder, shift down to 1st gear, then lift up on the shift pedal while standing still. The transmission will shift only into neutral.

Vehicle speed when shifting

Shifting up	km/h (mph)	Shifting down	km/h (mph)
1st → 2nd	15 (9)	6th → 5th	30 (19)
2nd → 3rd	25 (15)	5th → 4th	25 (15)
3rd → 4th	35 (21)	4th → 3rd	20 (12)
4th → 5th	45 (27)	3rd → 2nd	15 (9)
5th → 6th	55 (34)	2nd → 1st	15 (9)

Braking

- Close the throttle completely, leaving the clutch engaged (except when shifting gears) so that the engine will help slow down the motorcycle.
- Shift down one gear at a time so that you are in 1st gear when you come to a complete stop.
- When stopping, always apply both brakes at the same time. Normally the front brake should be applied a little more than the rear. Shift down or fully disengage the clutch as necessary to keep the engine from stalling.
- Never lock the brakes, or it will cause the tires to skid. When turning a corner, it is better not to brake at all; but if this is unavoidable, use only the rear brake.
- For emergency braking, disregard downshifting, and concentrate on applying the brakes as hard as possible without skidding.

CAUTION

- In order to protect the emission control parts, do not turn off the ignition switch when the motorcycle is in motion.

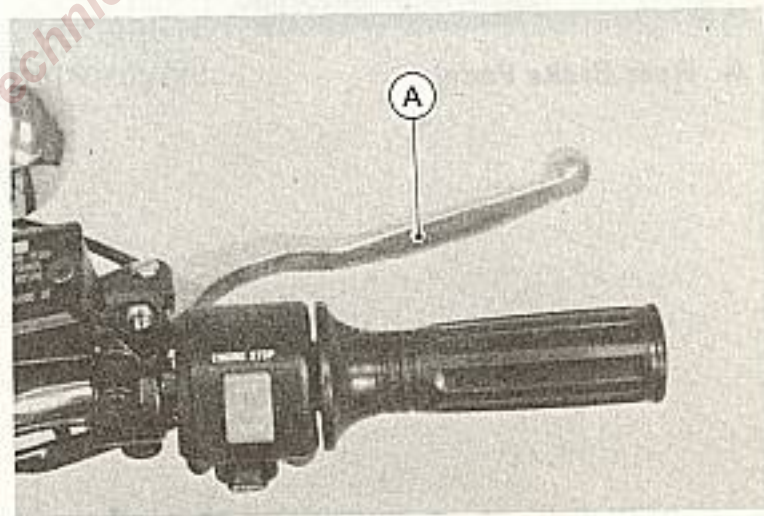

A. Front Brake Lever

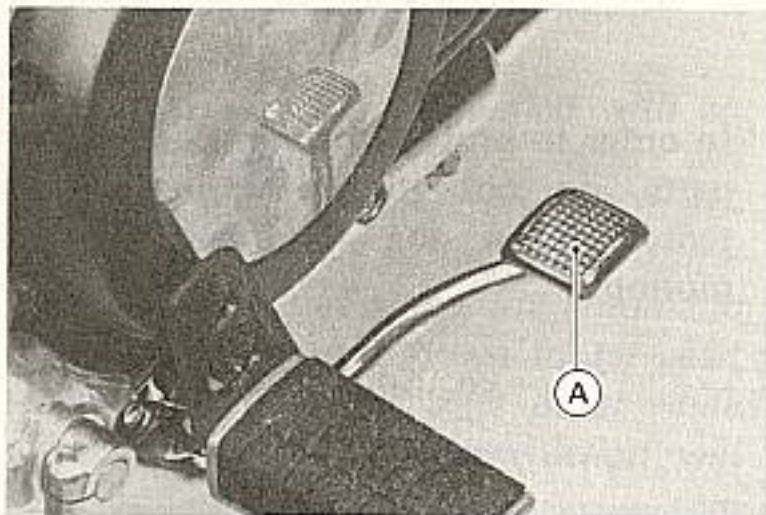

A. Rear Brake Pedal

Stopping the Engine

- Close the throttle completely.
- Shift the transmission into neutral.
- Turn the ignition switch off.
- Support the motorcycle on a firm level surface with the side stand.
- Lock the steering.

Stopping the Motorcycle in an Emergency

Your Kawasaki Motorcycle has been designed and manufactured to provide you optimum safety and convenience. However, in order to fully benefit from Kawasaki's safety engineering and craftsmanship, it is essential that you, the owner and operator, properly maintain your motorcycle and become thoroughly familiar with its operation. Improper maintenance and insufficient riding skills can create a dangerous situation known as throttle failure. Two of the most common causes of throttle failure are:

1. During removal of the air cleaner by the owner, dirt is allowed to enter and jam the carburetor.
2. A novice may forget which direction the throttle rotates; then jerk the throttle wide open thinking he has shut it off; panic when the machine

accelerates suddenly instead of slowing down; and "freeze", holding the throttle wide open.

In an emergency situation such as throttle failure, your motorcycle may be stopped by disengaging the clutch and applying the brakes. Once this stopping procedure is initiated, the engine stop switch may be used to stop the engine. If the engine stop switch is used, turn off the ignition switch after stopping the motorcycle.

Parking

- Shift the transmission into neutral and turn the ignition switch OFF.
- Support the motorcycle on a firm level surface with the side stand.

CAUTION

- Do not park on a soft or steeply inclined surface or the motorcycle may fall over.
- If parking inside a garage or other structure, be sure it is well ventilated and the motorcycle is not close to any source of flame or sparks; this includes any appliance with a pilot light.

WARNING

- Gasoline is extremely flammable and can be explosive under certain conditions.

- Lock the steering to help prevent theft.

NOTE

- When stopping near traffic at night, you can leave the taillight on for greater visibility by turning the ignition switch to the P (park) position.
- Do not leave the switch at P position too long, or the battery will discharge.

SAFE OPERATION

Safe Riding Technique

The points given below are applicable for everyday motorcycle use and should be carefully observed for safe and effective vehicle operation.

For safety, eye protection and a helmet are strongly recommended. Gloves and suitable footwear should also be used for added protection in case of a mishap.

A motorcycle does not provide the impact protection of an automobile, so defensive riding in addition to wearing protective apparel is extremely important. Do not let protective apparel give you a false sense of security.

Before changing lanes, look over your shoulder to make sure the way is clear. Do not rely solely on the rear view mirror; you may misjudge a vehicle's distance and speed, or you may not see it at all.

When going up steep slopes, shift to a lower gear so that there is plenty of power to spare rather than overloading the engine.

When applying the brakes, use both the front and rear brakes. Applying only one brake for sudden braking may cause the motorcycle to skid and lose control.

When going down long slopes, control vehicle speed by closing the throttle. Use the front and rear brakes for auxiliary braking.

On rainy days, rely more on the throttle to control vehicle speed and less on the front and rear brakes. The throttle should also be used judiciously to avoid skidding the rear wheel from too rapid acceleration or deceleration.

Riding at the proper rate of speed and avoiding unnecessarily fast acceleration are important not only for safety and low fuel consumption but also for long vehicle life and quieter operation.

When riding in wet conditions or on loose roadway surfaces, the ability to maneuver will be reduced. All of your actions should be smooth under these conditions. Sudden acceleration, braking or turning may cause loss of control.

On rough roads, exercise caution, slow down, and grip the fuel tank with the knees for better stability.

When quick acceleration is necessary as in passing, shift to a lower gear to obtain the necessary power.

Do not downshift at too high an r/min (rpm) to avoid damage to the engine from overrevving.

Avoiding unnecessary weaving is important to the safety of both the rider and other motorists.

Daily Safety Checks

Check the following items each day before you ride. The time required is minimal, and habitual performance of these checks will help ensure you a safe, reliable ride.

If any irregularities are found during these checks, refer to the Maintenance and Adjustment chapter or see your dealer for the action required to return the motorcycle to a safe operating condition.

WARNING

○ Failure to perform these checks every day before you ride may result in serious damage or a severe accident.

- Fuel Adequate supply in tank, no leaks.
- Engine oil Oil level between level lines.
- Tires Air pressure (when cold)

Front	225 kPa (2.25 kg/cm ² , 33 psi)
Rear	280 kPa (2.80 kg/cm ² , 40 psi)

- Nuts, bolts, fasteners Check that steering and suspension components, axles, and all controls are properly tightened or fastened.

Steering.	Action smooth but not loose from lock to lock. No binding of control cables.
Brakes.	No brake fluid leakage. Brake pad wear: Lining thickness more than 1 mm (0.04 in) left.
Throttle.	Throttle grip play 2 ~ 3 mm (0.08 ~ 0.12 in).
Clutch.	No clutch fluid leakage.
Coolant	No coolant leakage. Coolant level between level lines (when engine is cold).
Radiator cap.	Properly installed.
Final gear case	No oil leakage.
Electrical equipment	All lights and horn work.
Engine stop switch.	Stops engine.
Side stand	Return to its fully up position by spring tension. Return spring not weak or not damaged.

Refer to "Daily Safety Checks" caution label attached to the rear fender (or the bottom of the seat).

Additional Considerations for High Speed Operation

Brakes: The importance of the brakes, especially during high speed operation, cannot be overemphasized. Check to see that they are correctly adjusted and functioning properly.

Steering: Looseness in the steering can cause loss of control. Check to see that the handlebar turns freely but has no play.

Tires: High speed operation is hard on tires, and good tires are crucial for riding safety. Examine their overall condition, inflate to the proper pressure, and check the wheel balance.

Spark Plugs: For demanding operation such as racing, install one heat range colder spark plugs – US model: NGK D9EA or ND X27ES-U, Canadian model: NGK DR8ES or ND X27ESR-U.

Fuel: Have sufficient fuel for the high fuel consumption during high speed operation.

Engine Oil: To avoid seizure and resulting loss of control, make certain the oil level is at the upper level line.

Coolant: To avoid overheating, check that the coolant level is at the upper level line.

Final Gear Case Oil: To avoid seizure and resulting loss of control, make certain the oil level is correct.

Electrical Equipment: Make certain that the headlight, tail/brake light, turn signals, horn, etc., all work properly.

Miscellaneous: Make certain that all nuts and bolts are tight and that all safety related parts are in good condition.

WARNING

- **Handling characteristics of a motorcycle at high speeds may vary from those you are familiar with at legal highway speeds. Do not attempt high speed operation unless you have received sufficient training and have the required skills.**

MAINTENANCE AND ADJUSTMENT

The maintenance and adjustments outlined in this chapter are easily carried out and must be done in accordance with the Periodic Maintenance Chart to keep the motorcycle in good running condition. **The initial maintenance is vitally important and must not be neglected.**

If you are in doubt as to any adjustment or vehicle operation, please ask your authorized Kawasaki Dealer to check the motorcycle.

Please note that Kawasaki cannot assume any responsibility for damage resulting from incorrect maintenance or improper adjustment done by the owner.

Operation	Frequency	*Odometer Reading km (mi)							
	Whichever comes first ↓ Every	800 (500)	5 000 (3 000)	10 000 (6 000)	15 000 (9 000)	20 000 (12 000)	25 000 (15 000)	30 000 (18 000)	See Page
Brake pad wear—check †			•	•	•	•	•	•	84
Brake/clutch fluid level—check †	month	•	•	•	•	•	•	•	85, 83
K Brake/clutch fluid—change	2 years					•			85, 83
K Steering—check †		•	•	•	•	•	•	•	—
Final gear case oil level—check †				•		•		•	69
Final gear case oil—change		•						•	69
K Propeller shaft joint—lubricate				•				•	—
Nut, bolt, and fastener tightness—check †		•		•		•		•	108
Tire wear—check †			•	•	•	•	•	•	95
Engine oil—change	year	•		•		•		•	57
Oil filter—replace		•		•		•		•	57
General lubrication—perform			•	•	•	•	•	•	106
K Front fork oil—change								•	—

Operation	Frequency	Whichever comes first ↓	*Odometer Reading							See Page
			800 (500)	5 000 (3 000)	10 000 (6 000)	15 000 (9 000)	20 000 (12 000)	25 000 (15 000)	30 000 (18 000)	
Non-Emission Related	K Swing arm pivot—lubricate				•				•	—
	Coolant—change	2 years							•	65
	Radiator hoses, connections —check †	year	•		•		•		•	64
	K Steering stem bearing—lubricate	2 years					•			—
	K Brake/clutch master cylinder cup and dust seal—replace	2 years								—
	K Caliper piston seal and dust seal—replace	2 years								—
	K Clutch slave cylinder piston seal —replace	2 years								—
	K Brake/clutch hose and pipe—replace	4 years								—
K Fuel hose—replace	4 years								—	

K : Should be serviced by an authorized Kawasaki Dealer.

• : For higher odometer readings, repeat at the frequency interval established here.

† : Replace, add, adjust, or torque if necessary.

(C): Californian model only

Engine Oil

In order for the engine, transmission, and clutch to function properly, maintain the engine oil at the proper level, and change the oil and oil filter in accordance with the Periodic Maintenance Chart. Not only do dirt and metal particles collect in the oil, but the oil itself loses its lubricative quality if used too long.

WARNING

○Motorcycle operation with insufficient, deteriorated, or contaminated engine oil will cause accelerated wear and may result in engine or transmission seizure, accident, and injury.

Oil Level Inspection

●If the oil has just been changed, start the engine and run it for several minutes at idle speed. This fills the oil filter with oil. Stop the engine, then wait several minutes until the oil settles.

CAUTION

- Racing the engine before the oil reaches every part can cause engine seizure.
- If the motorcycle has just been used, wait several minutes for all the oil to drain down.
- Check the engine oil level through the oil level gauge. With the motorcycle held level, the oil level should come up between the lines next to the gauge.

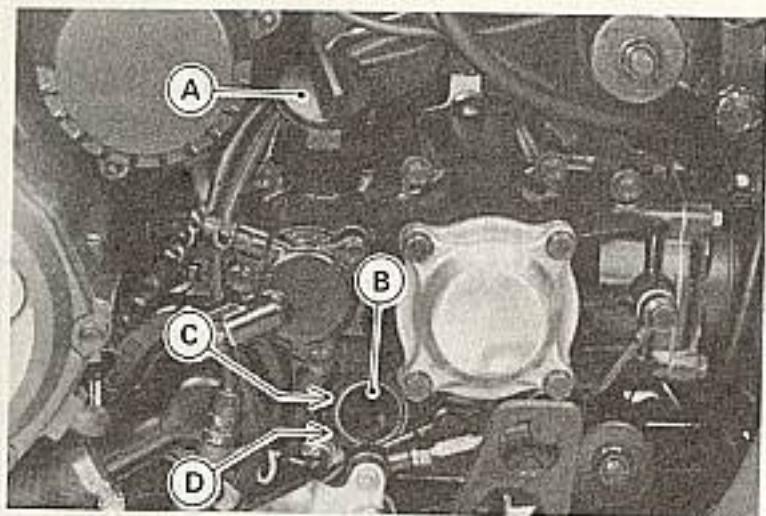

A. Oil Filler Cap
B. Oil Level Gauge

C. Upper Level
D. Lower Level

- If the oil level is too high, remove the excess oil, using a syringe or some other suitable device.
- If the oil level is too low, add the correct amount of oil through the oil filler opening. Use the same type and brand of oil that is already in the engine.

CAUTION

- If the engine oil gets extremely low or if the oil pump or oil passages clog up or otherwise do not function properly, the oil pressure warning light will light. If the light stays on when the engine speed is above 1,500 r/min (rpm), stop the engine immediately and find the cause.

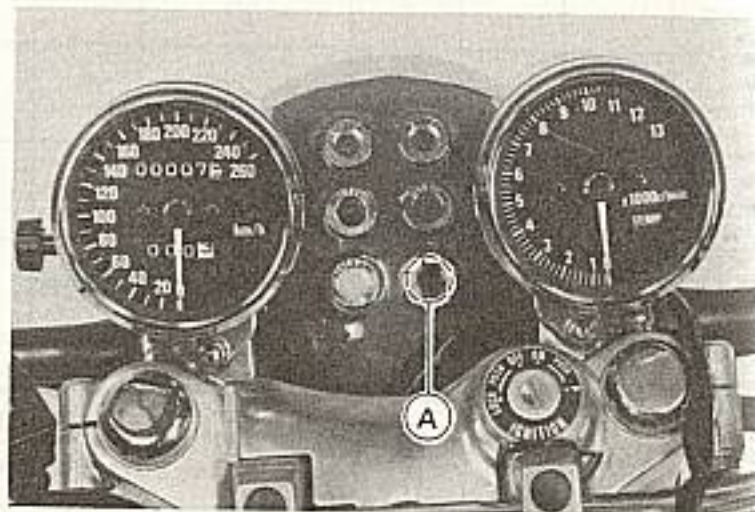

A. Oil Pressure Warning Light

Oil and/or Oil Filter Change

- Warm up the engine thoroughly, and then stop the engine.
- Place an oil pan beneath the engine.
- Remove the engine drain plugs.

- With the motorcycle perpendicular to the ground, let the oil completely drain.
- If the oil filter is to be changed, remove the oil filter mounting bolt and drop out the oil filter.
- Replace the oil filter element with a new one.

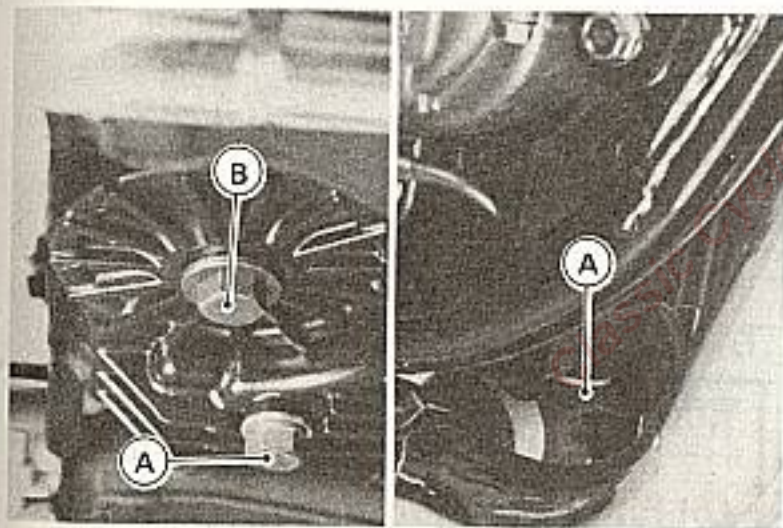

A. Drain Plugs
B. Oil Filter Mounting Bolt

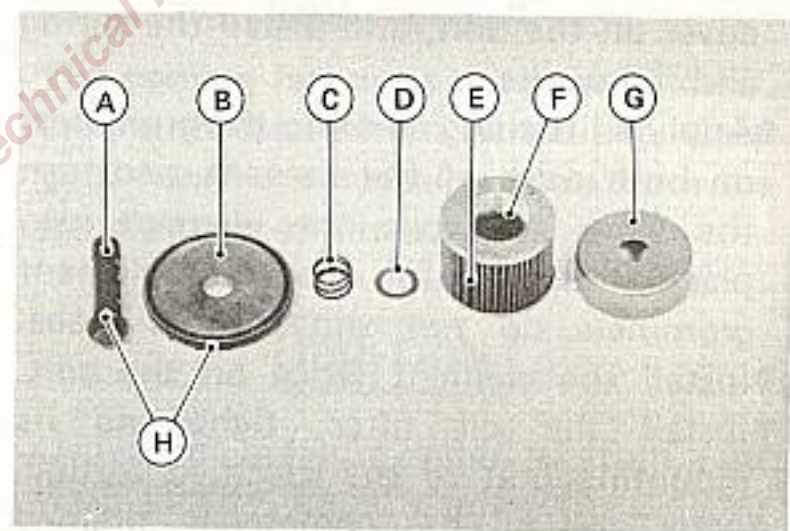

A. Mounting Bolt
B. Filter Cover
C. Spring
D. Flat Washer
E. Element
F. Grommet
G. Element Fence
H. O-Ring

NOTE

- *Check for O-ring damage. If necessary, replace them with new ones.*
- *When installing the oil filter, make sure the O-rings are in place.*
- Apply a little engine oil to the O-ring on the filter mounting bolt, fit the filter cover on the bolt, and install the spring and flat washer.
- Apply a little engine oil to the grommets on both sides of the element, and turn the filter to work the element into place. Be careful that the element grommets do not slip out of place.
- Install the element fence on the bolt.
- Install the oil filter, tightening its mounting bolt to the specified torque.
- After the oil has completely drained out, install the engine drain plug with its gasket. Proper torque for it is shown in the table.

NOTE

- *Replace the damaged gasket with a new one.*
- Fill the engine up to the upper level with a good quality motor oil specified in the table.
- Check the oil level.

Tightening Torque

Engine Oil Drain Plugs:

29 N-m (3.0 kg-m, 22 ft-lb)

Oil Filter Mounting Bolt:

20 N-m (2.0 kg-m, 14.5 ft-lb)

Engine Oil

Grade:	SE or SF class
Viscosity:	SAE 10W40, 10W50, 20W40, or 20W50
Capacity:	2.7 L (2.9 US qt) [when filter is not removed]
	3.0 L (3.2 US qt) [when filter is removed]

Cooling System

Radiator and Cooling Fan

Check the radiator fins for obstruction by insects or mud. Clean off any obstructions with a stream of low-pressure water.

WARNING

- The cooling fan turns on automatically, even with the ignition switch off. Keep your hands and clothing away from the fan blades at all times.

CAUTION

- Using high-pressure water, as from a car wash facility, could damage the radiator fins and impair the radiator's effectiveness.
- Do not obstruct or deflect airflow through the radiator by installing

unauthorized accessories in front of the radiator or behind the cooling fan. Interference with the radiator airflow can lead to overheating and consequent engine damage.

Coolant

Coolant absorbs excessive heat from the engine and transfers it to the air at the radiator. If the coolant level becomes low, the engine overheats and may suffer severe damage. Check the coolant level each day before riding the motorcycle, and replenish coolant if the level is low. Change the coolant in accordance with the Periodic Maintenance Chart.

Information for Coolant:

To protect the cooling system (consisting of the aluminum engine and radiator)

from rust and corrosion, the use of corrosion and rust inhibitor chemicals in the coolant is essential. If coolant containing corrosion and rust inhibitor chemicals is not used, over a period of time, the cooling system accumulates rust and scale in the water jacket and radiator. This will clog up the coolant passages, and considerably reduce the efficiency of the cooling system.

WARNING

○Use coolant containing corrosion inhibitors made specifically for aluminum engines and radiators in accordance with the instructions of the manufacturer. Chemicals are harmful to the human body.

Soft or distilled water must be used with the antifreeze (see below for antifreeze) in the cooling system.

CAUTION

○If hard water is used in the system, it causes scale accumulation in the water passages, and considerably reduces the efficiency of the cooling system.

If the lowest ambient temperature encountered falls below the freezing point of water, use permanent antifreeze in the coolant to protect the cooling system against engine and radiator freeze-up, as well as from rust and corrosion.

Use a permanent type of antifreeze (soft water and ethylene glycol plus corrosion and rust inhibitor chemicals for aluminum engines and radiators) in the cooling system. On the mixture ratio of coolant, choose the suitable one referring to the relation between freezing point and strength directed on the container.

CAUTION

○Permanent types of antifreeze on the market have anti-corrosion and anti-rust properties. When it is diluted excessively, it loses its anti-corrosion property. Dilute a permanent type of antifreeze in accordance with the instructions of manufacturer.

NOTE

○A permanent type of antifreeze is installed in the cooling system when shipped. It is colored green, contains a 43% solution of ethylene glycol, and has the freezing point of -30°C (-22°F).

Coolant Level Inspection

●Situating the motorcycle so that it is perpendicular to the ground.

- Unlock the seat and swing it up.
- Check the coolant level in the reserve tank. The coolant level should be between the FULL and LOW marks.

NOTE

- Check the level when the engine is cold (room or atmospheric temperature).

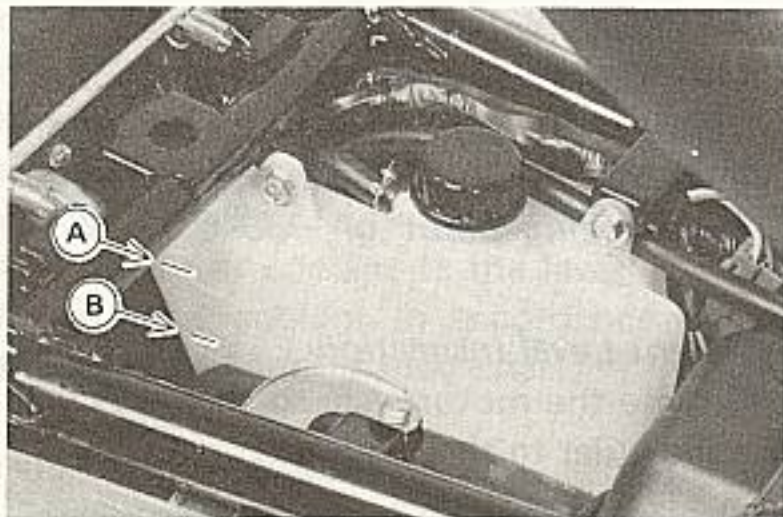

A. FULL Mark

B. LOW Mark

- If the amount of coolant is insufficient, unscrew the cap from the reserve tank, and add coolant through the filler opening to the FULL mark. Install the cap.

NOTE

- In an emergency you can add water alone to the coolant reserve tank, however it must be returned to the correct mixture ratio by the addition of antifreeze concentrate as soon as possible.

CAUTION

- If coolant must be added often, or the reserve tank completely runs dry, there is probably leakage in the system. Have the cooling system inspected by your authorized Kawasaki Dealer.

Coolant Change

WARNING

○To avoid burns, do not remove the radiator cap or try to change the coolant when the engine is still hot. Wait until it cools down.

- Set the motorcycle up on its side stand.
- Unlock the seat and swing it up.
- Remove the fuel tank mounting bolts and move the tank a little rearward for the radiator cap to fully appear. Take care that the fuel hoses do not slip out of place.
- Remove the left frame gadget.
- Remove the radiator cap in two steps. First turn the cap counterclockwise to the first stop and wait there for a few seconds. Then push and turn it further in the same direction and remove the cap.

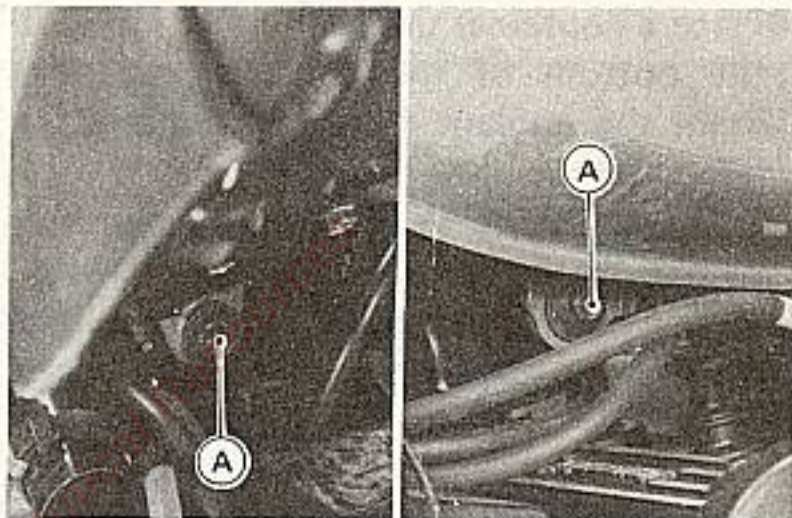

A. Fuel Tank Mounting Bolt

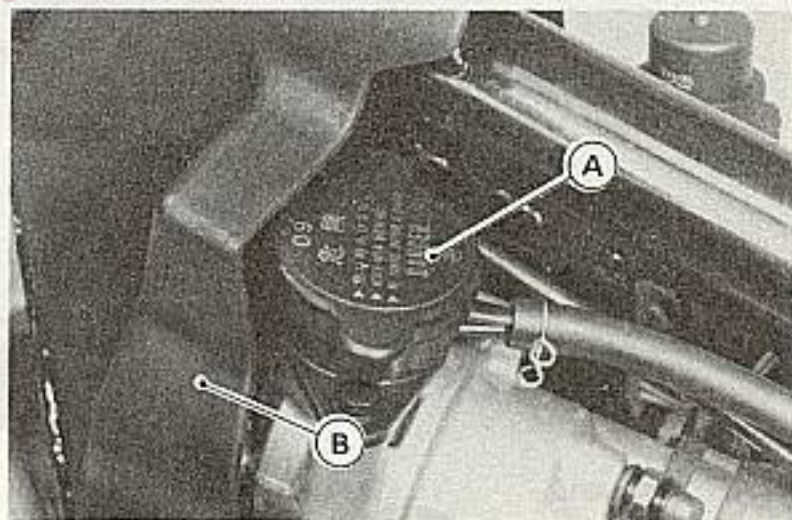

A. Radiator Cap B. Frame Gadget

- Place a container under the drain plug at the bottom of the coolant pipe, and drain the coolant from the radiator by removing the drain plug.

Coolant begins to flow out when the plug is loosened several turns. Immediately wipe up or wash out any spilled coolant on the frame, engine, or wheels.

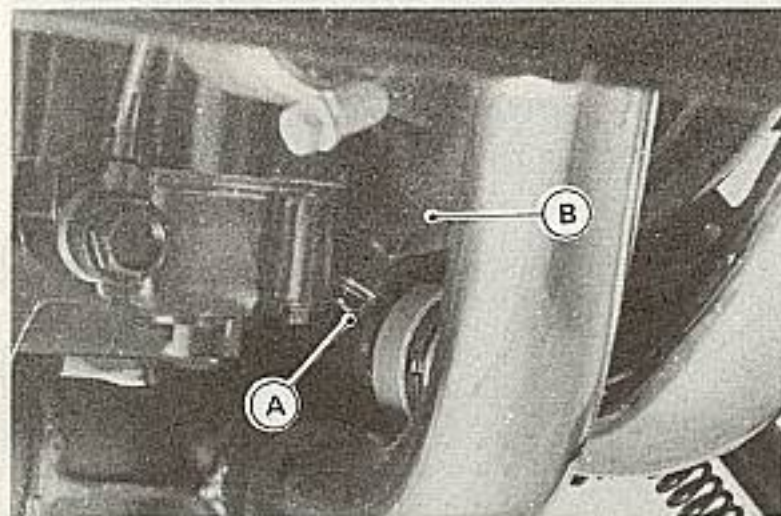

A. Drain Plug

B. Coolant Pipe

WARNING

- Coolant on tires will make them slippery and can cause an accident and injury.

- Visually inspect the old coolant. If whitish cotton-like wafts are observed, aluminum parts in the cooling system are corroded. A brownish color of the coolant indicates rusting of iron parts. If the coolant gives off an abnormal smell when changing, it may be caused by exhaust gas leaking into the cooling system (coolant leaks into engine). In this case, have the cooling system checked by your authorized Kawasaki Dealer.

- Swing up the seat.
- Remove the reserve tank by removing the mounting bolts.

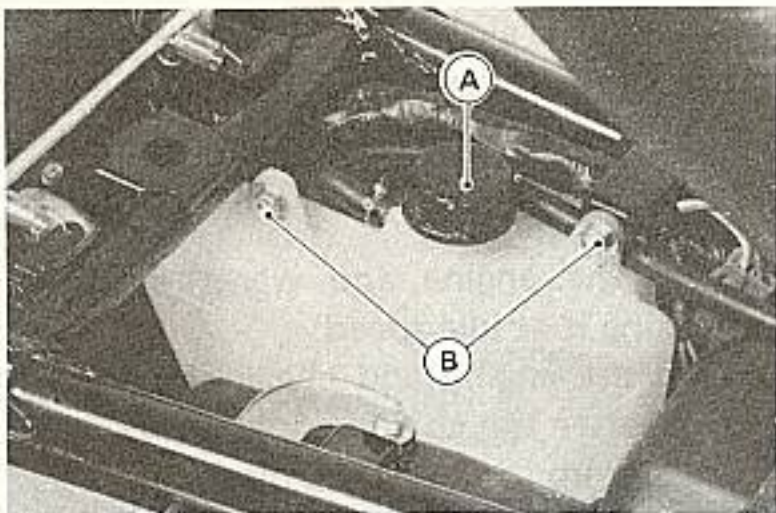

A. Cap

B. Bolts

- Unscrew the cap off the reserve tank, and pour the coolant into a container.
- Install the reserve tank and cap.
- Install the drain plug with the specified torque shown in the table. Always replace the O-ring and the gasket with new ones, if they are damaged.

Tightening Torque

Drain Plug:

7.8 N-m (0.8 kg-m, 69 in-lb)

- Fill the radiator up to the radiator filler neck with coolant.

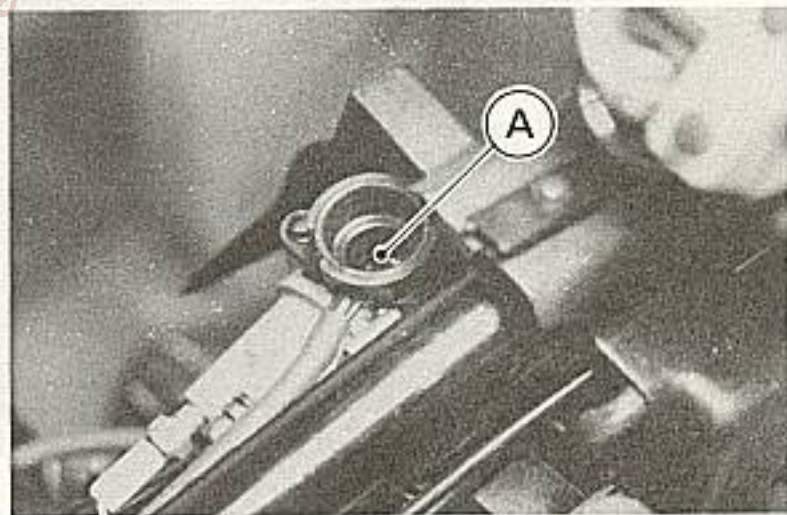

A. Radiator Filler Neck

- Fill the reserve tank up to the FULL mark with coolant, and install the cap. Total refill will take about 3.1 L (3.3 US qt) after the air inside the system is expelled.
- Loosen the air bleeder bolt at the water pump cover, and coolant begins to flow out the air bleeder bolt hole (that is, all the remaining air is forced out).

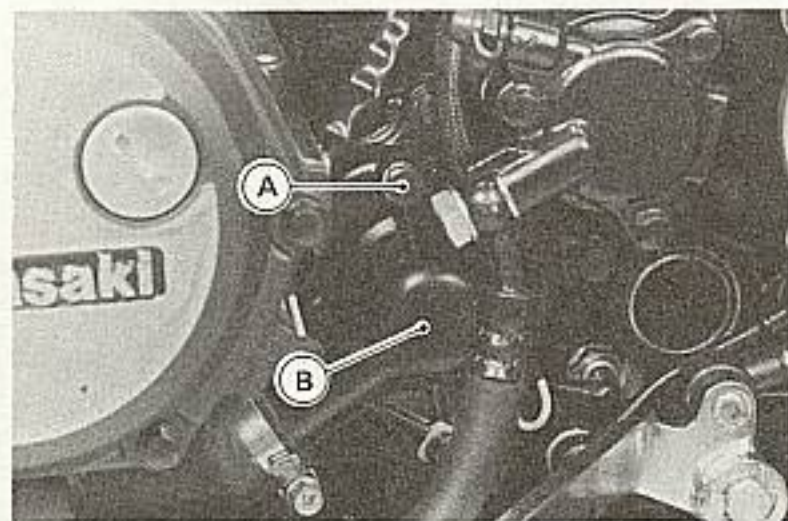

A. Air Bleeder Bolt
B. Water Pump Cover

- Tighten the air bleeder bolt.
- Install the radiator cap, turning it clockwise by about ¼ turn.
- Install the left frame gadget and the fuel tank.
- Start the engine and warm it up by running it at idle speed.
- Stop the engine and check the coolant level after the engine cools down. Add coolant up to the FULL mark.
- Inspect the drain plug and the radiator cap for leaks.

Final Gear Case Oil

In order for the pinion and ring gears in the final gear case to function properly, check the oil level, and change the oil in accordance with the Periodic Maintenance Chart.

WARNING

Motorcycle operation with insufficient, deteriorated, or contaminated oil causes accelerated wear and may result in seizure of the pinion and ring gears. Seizure can lock the rear wheel and skid the rear tire, with consequent loss of control.

Oil Level Inspection

- Have a helper hold the motorcycle vertical on level ground.
- Remove the filler cap.

CAUTION

- Be careful not to allow any dirt or foreign material to enter the gear case.
- Check the oil level. If it is low, add oil as necessary. The oil level should come to the bottom thread of the filler opening with the motorcycle held vertical on level ground.

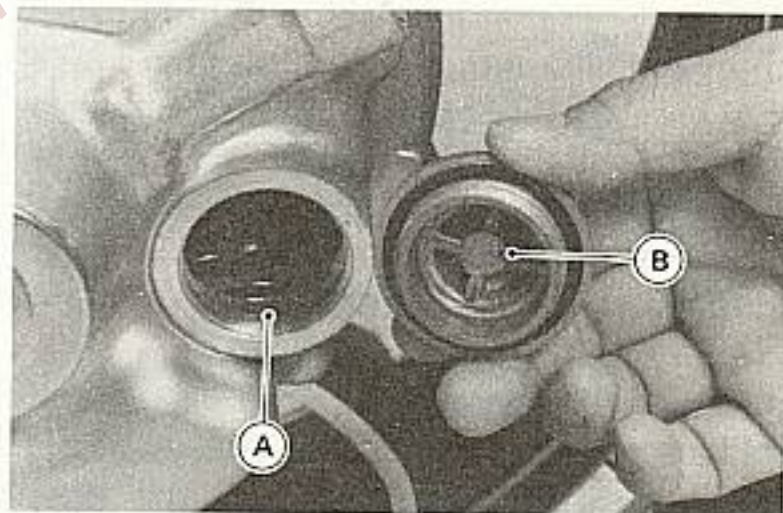

A. Bottom Thread

B. Filler Cap

NOTE

- *Use the same type and brand of oil that is already in the final gear case.*

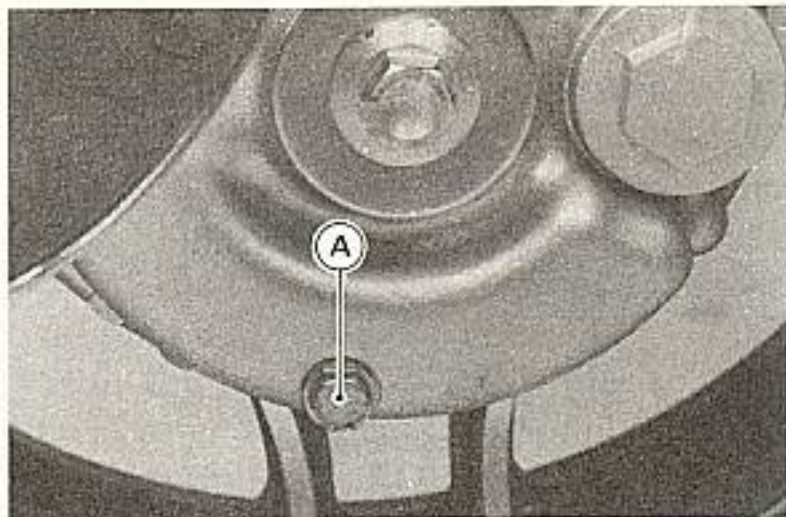

A. Drain Plug

Oil Change

NOTE

- *Final gear case oil drains easily and picks up any sediment when the oil is warmed up by running the motorcycle.*

- Put the motorcycle on its side stand.
- Place an oil pan beneath the gear case.
- Remove the filler cap and the drain plug.

WARNING

- When draining or filling the gear case, be careful that no oil gets on the tire, rim, or brake disc. Clean off any oil that inadvertently gets on them with soap and water.
- After the oil has completely drained out, install the drain plug and gasket.

Replace the damaged gasket with a new one.

- With the motorcycle held vertical on level ground, fill the gear case up to the bottom thread of the filler opening with the oil specified below.

Final Gear Case Oil

Oil Capacity	about 220 mL (0.23 US qt)
Oil Type	API "GL-5" Hypoid gear oil above 5°C (41°F) SAE 90 below 5°C (41°F) SAE 80

NOTE

○"GL-5" indicates a quality and additive rating. "GL-6" rated hypoid gear oils can also be used.

- Install the filler cap.

Spark Plugs

The standard spark plug is shown in the table. The spark plugs should be taken out periodically in accordance with the Periodic Maintenance Chart for cleaning, inspection, and resetting of the plug gap.

Spark Plug Removal

- Turn the fuel tap to the ON position.
- Unlock the seat and swing it up.
- Slide the hose clamps down, and disconnect the fuel hoses from the fuel tap.
- Remove the fuel tank mounting bolts and remove the tank from the motorcycle (See Coolant Change in the Cooling System section).
- Use the spark plug wrench in the tool kit when removing spark plugs.

Maintenance

If the plug is oily or has carbon built up on it, have it cleaned, preferably in a sand-blasting device, and then clean off any abrasive particles. The plug may also be cleaned using a high flash-point solvent and a wire brush or other suitable tool. Measure the gap with a wire-type thickness gauge, and adjust the gap if incorrect by bending the outer electrode. If the spark plug electrodes are corroded or damaged, or if the insulator is cracked, replace the plug. Use the standard plug or its equivalent.

Spark Plug

Standard Plug	NGK D8EA or ND X24ES-U
	© NGK DR8ES-L or ND X24ESR-U
Plug Gap	0.6 ~ 0.7 mm (0.024 ~ 0.028 in)
Tightening Torque	14 N·m (1.4 kg·m, 10 ft·lb)

© : Canadian model

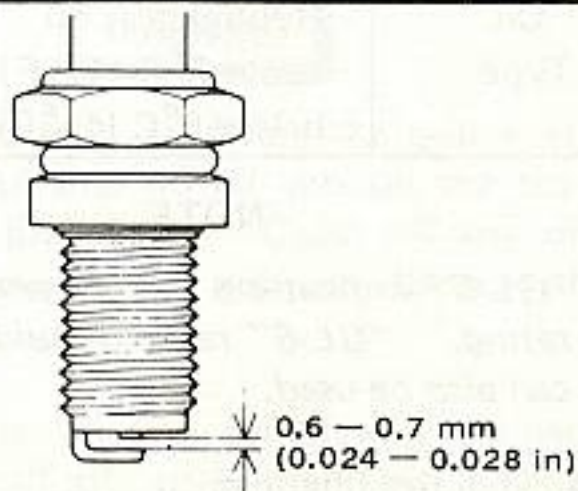

CAUTION

- For cold weather and/or low speed riding, a hotter spark plug shown in the table may be used for quicker warm-ups and more efficient engine operation.

Hotter Spark Plug

NGK D7EA or ND X22ES-U
© NGK DR7ES or ND X22ESR-U

© : Canadian model

Valve Clearance

Valve and valve seat wear decreases valve clearance, upsetting valve timing.

CAUTION

- If valve clearance is left unadjusted, the wear will eventually cause the valves to remain partly open; which lowers performance, burns the valves and valve seats, and may cause serious engine damage.

Valve clearance for each valve should be checked and adjusted in accordance with the Periodic Maintenance Chart.

Inspection and adjustment should be done only by a competent mechanic following the instructions in the Service Manual.

Kawasaki Clean Air System

The Kawasaki Clean Air System (KCA) is a secondary air suction system that helps the exhaust gases to burn more completely. When the spent fuel charge is released into the exhaust system, it is still hot enough to burn. The KCA System allows extra air into the exhaust system so that the spent fuel charge can continue to burn. This continued burning action tends to burn up a great deal of the normally unburned gases, as well as changing a significant portion of the poisonous carbon monoxide into harmless carbon dioxide.

Air Suction Valves:

The air suction valve is essentially a check valve which allows fresh air to flow only from the air cleaner into the exhaust port. Any air that has passed the air suction valve is prevented from returning.

Inspect the air suction valves in accordance with the Periodic Maintenance Chart. Also, inspect the air suction valves whenever stable idling cannot be obtained, engine power is greatly reduced, or there are abnormal engine noises.

Air suction valve removal and inspection should be done only by a competent mechanic following the instructions in the Service Manual.



Evaporative Emission Control System (Californian model only)

This system routes fuel vapors from the fuel system into the running engine or stores the vapors in a canister when the engine is stopped. Although no adjustments are required, a thorough visual inspection must be made at the intervals specified by the Periodic Maintenance Chart.

Inspection

- Check that the hoses are securely connected.
- Replace any kinked, deteriorated, or damaged hoses.

VACUUM HOSE ROUTING DIAGRAM

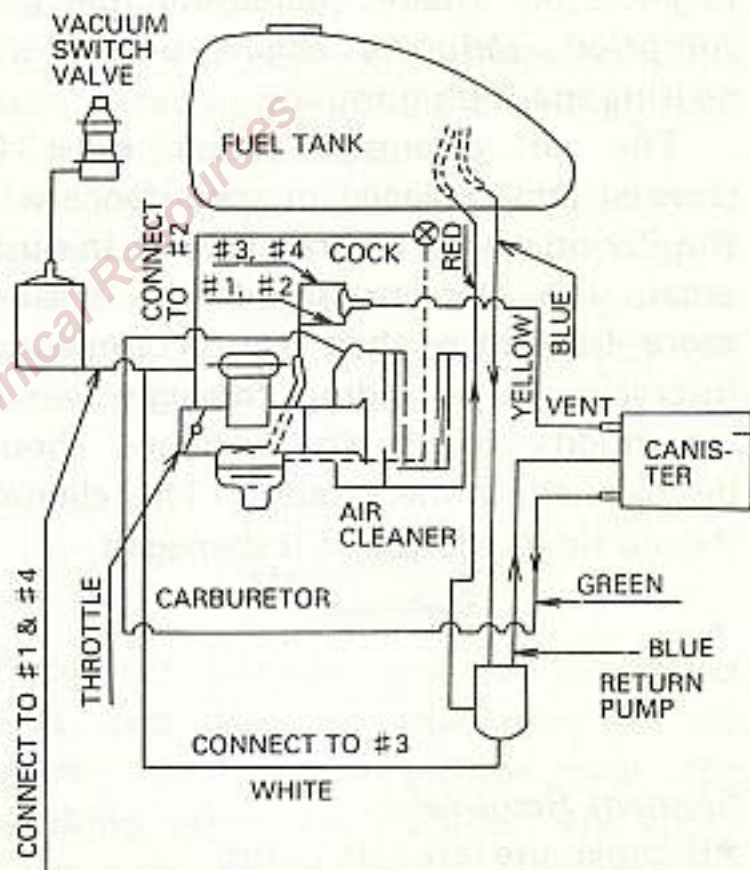

Air Cleaner

A clogged air cleaner restricts the engine's air intake, increasing fuel consumption, reducing engine power, and causing spark plug fouling.

The air cleaner element must be cleaned and replaced in accordance with the Periodic Maintenance Chart. In dusty areas, the element should be cleaned more frequently than the recommended interval. After riding through rain or on muddy roads, the element should be cleaned immediately. The element should be replaced if it is damaged.

Element Removal

- Remove the left side cover.
- Unscrew the air cleaner housing cap.
- Pull out the plastic wedge, and then the element.

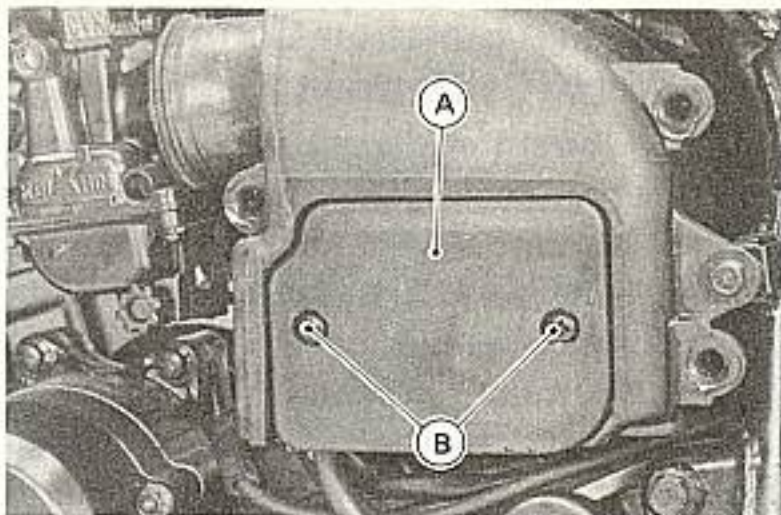

A. Air Cleaner Housing Cap B. Screws

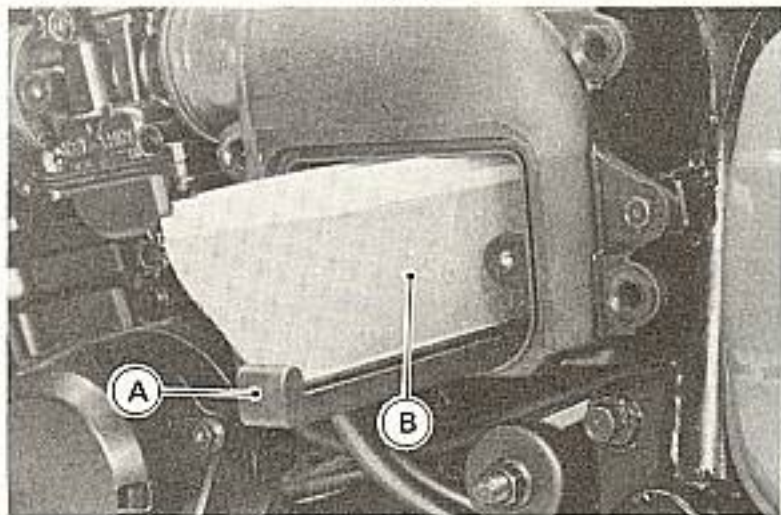

A. Plastic Wedge B. Element

- Push a clean, lint-free towel into the air cleaner housing to keep dirt or other foreign material from entering.
- Inspect the element material and sponge gasket for damage. If any part of the element is damaged, the element must be replaced.

WARNING

- If dirt or dust is allowed to pass through into the carburetors, the throttle may become stuck, possibly causing accident.

CAUTION

- If dirt gets through into the engine, excessive engine wear and possibly engine damage will occur.

NOTE

- *Element installation is performed in the reverse order of removal.*

Element Cleaning

- Clean the element in a bath of a high flash-point solvent.
- Dry the element with compressed air.
- After cleaning, saturate the element with SE class SAE 30 motor oil.
- Press the element against a workbench to squeeze out the excess oil, then wrap it in a clean rag and squeeze it as dry as possible. Be careful not to deform the element frame.

WARNING

- Clean the element in a well ventilated area, and take care that there are no sparks or flame anywhere near the working area; this includes any appliance with a pilot light. Do not use gasoline or a low flash-point solvent to clean the element. A fire or explosion could result.

Throttle Grip

The throttle grip controls the throttle valves. If the throttle grip has excessive play due to either cable stretch or maladjustment, it will cause a delay in throttle response, especially at low engine speed. Also, the throttle valves may not open fully at full throttle. On the other hand, if the throttle grip has no play, the throttle will be hard to control, and the idle speed will be erratic. Check the throttle grip play periodically in accordance with the Periodic Maintenance Chart, and adjust the play if necessary.

Inspection

- Check that there is 2 ~ 3 mm (0.08 ~ 0.12 in) throttle grip play when lightly turning the throttle grip back and forth.
- If there is improper play, adjust it.

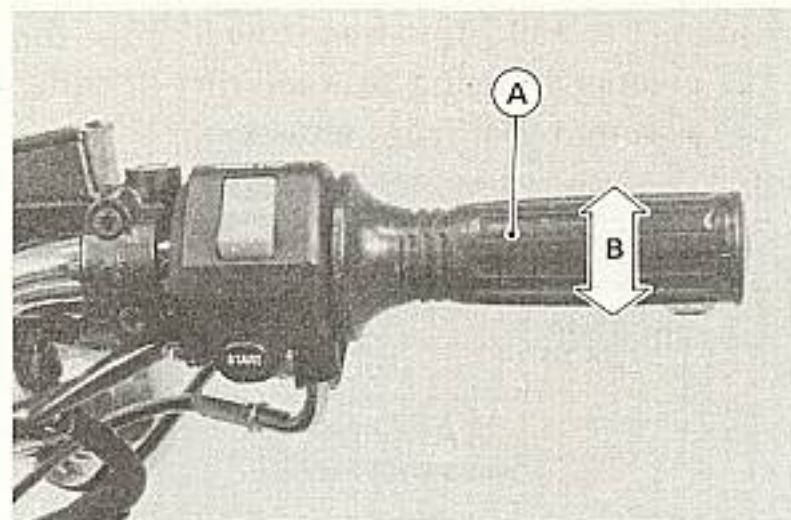

- A. Throttle Grip
- B. 2 ~ 3 mm (0.08 ~ 0.12 in)

Adjustment

- Loosen the locknuts, and screw both throttle cable adjusters in completely at the upper end of the throttle cables so as to give the throttle grip plenty of play.

- Turn out the decelerator cable adjuster until there is no play when the throttle grip is completely closed. Tighten the locknut.

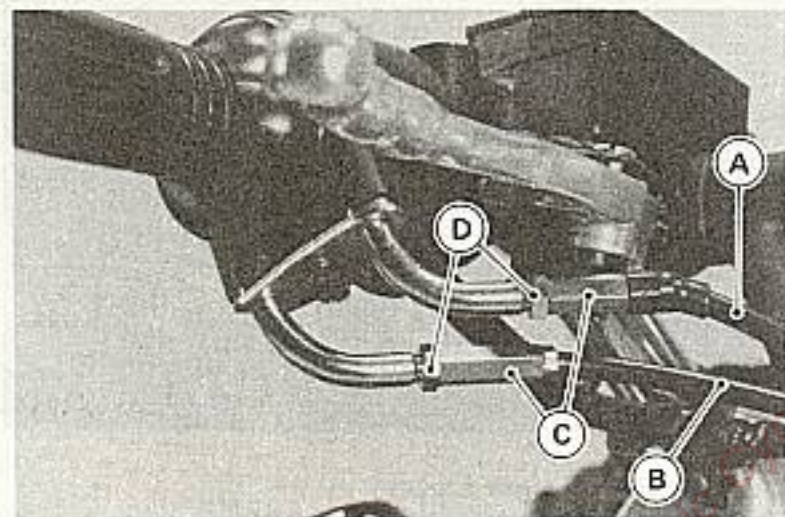

A. Accelerator Cable
B. Decelerator Cable
C. Adjusters
D. Locknuts

- Turn the accelerator cable adjuster until 2 ~ 3 mm (0.08 ~ 0.12 in) of throttle grip play is obtained. Tighten the locknut.

NOTE

○ If the throttle cables cannot be adjusted by using the cable adjusters at the upper end of the throttle cables, use the adjusters at the lower end of the cables (See Spark Plug Removal in the Spark Plugs section for fuel tank removal).

Choke Lever

By pulling the choke lever, the carburetor provides a rich starting mixture that is necessary to enable easy starting when the engine is cold.

If starting difficulty or rich fuel mixture trouble occurs, inspect the choke lever, and adjust it if necessary.

Inspection

- Check that the choke lever returns properly and that the inner cable slides smoothly. If there is any irregularity, have the choke cable checked by a competent mechanic following the instructions in the Service Manual.
- Push the choke lever back all the way to its released position.
- Determine the amount of choke cable play at the choke lever. Pull the choke lever until the starter plunger lever at the carburetor touches the starter

plunger; the amount of choke lever travel is the amount of choke cable play.

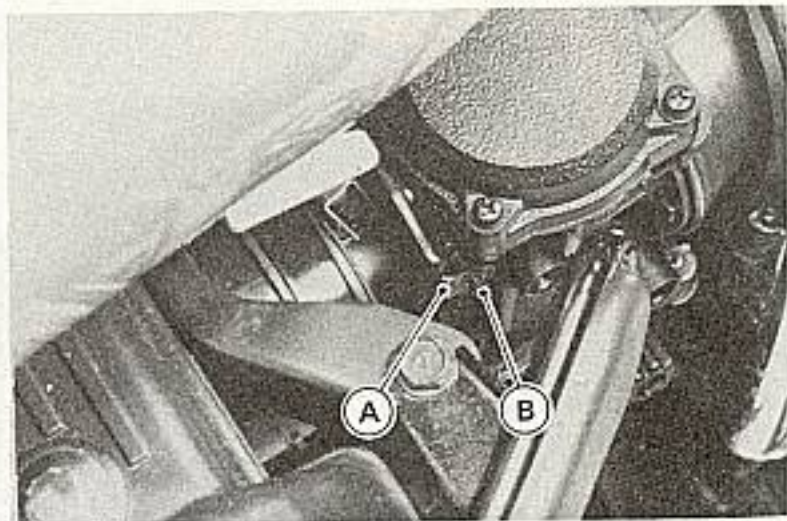

- A. Starter Plunger Lever
- B. Starter Plunger

- The proper amount of play is 2 ~ 3 mm (0.08 ~ 0.12 in) at the bottom of the choke lever. If there is too much or too little play, adjust the choke cable.

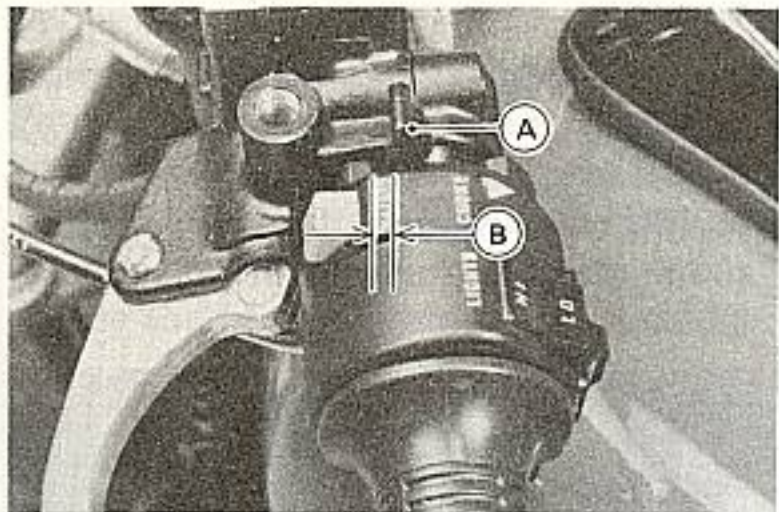

A. Choke Lever

B. 2 ~ 3 mm (0.08 ~ 0.12 in)

Adjustment

- Loosen the locknut at the upper end of the choke cable, and turn the adjuster until the cable has the proper amount of play.

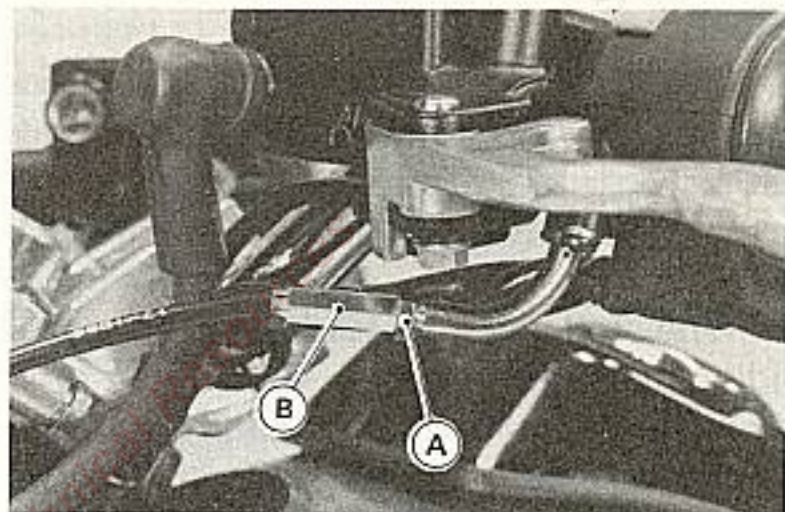

A. Locknut

B. Adjuster

- Tighten the locknut after adjustment.

Carburetors

The carburetor adjustments, idle speed and synchronization should be performed in accordance with the Periodic Maintenance Chart or whenever the idle speed is disturbed.

The following procedure covers the idle speed adjustment. Carburetor synchronization should be done only by a competent mechanic using vacuum gauges, following the instructions in the Service Manual.

NOTE

○ *Poor carburetor synchronization will cause unstable idling, sluggish throttle response, and reduced engine power and performance.*

Adjustment

- Start the engine, and warm it up thoroughly.
- Adjust the idle speed to 950 ~ 1,050 (Californian model: 1,150 ~ 1,250) r/min (rpm) by turning the idle adjusting screw.

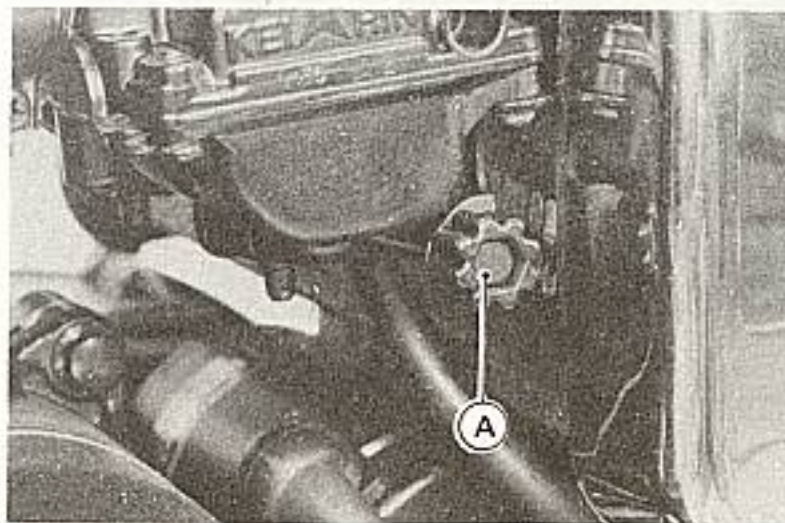

A. Idle Adjusting Screw

- Open and close the throttle a few times to make sure that the idle speed does not change. Readjust if necessary.

- With the engine idling, turn the handlebar to each side. If handlebar movement changes the idle speed, the throttle cables may be improperly adjusted or incorrectly routed, or they may be damaged. Be sure to correct any of these conditions before riding.

WARNING

- Operation with damaged cables could result in an unsafe riding condition.

Clutch

The motorcycle is equipped with a hydraulically operated clutch that requires no adjustment except fluid level inspection in accordance with the Periodic Maintenance Chart.

Fluid level inspection

- The fluid level in the reservoir must be kept between the upper and lower level lines (reservoir held horizontal).
- Fill the reservoir to the upper level line inside it.

NOTE

- Use the same fluid as is used in the brakes and keep the same requirements mentioned in the "Brakes" section.

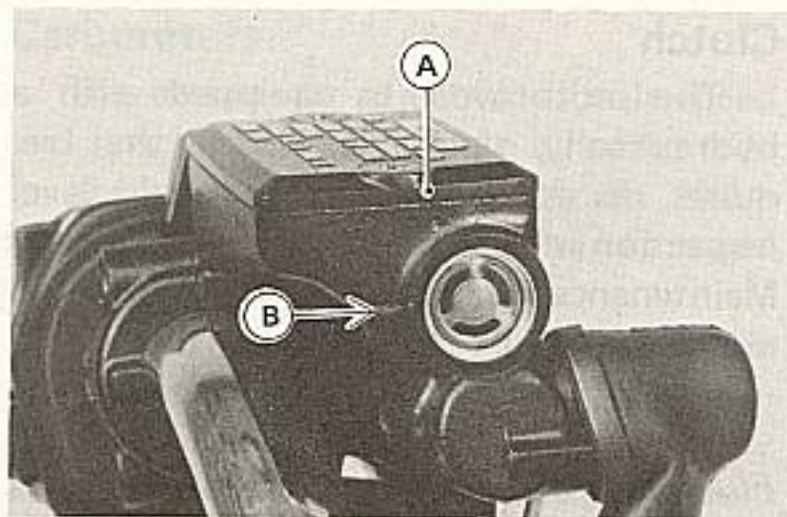

A. Reservoir

B. Lower Level

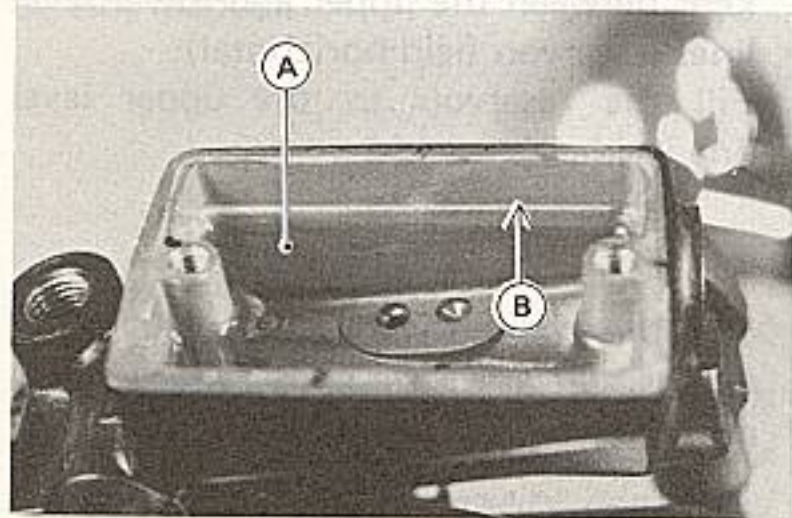

A. Reservoir

B. Upper Level

Brakes

Brake Wear Inspection

In accordance with the Periodic Maintenance Chart, inspect the brakes for wear. For each front and rear disc brake caliper, if the thickness of either pad is less than 1 mm (0.04 in), replace both pads in the caliper as a set. Pad replacement should be done by an authorized Kawasaki Dealer.

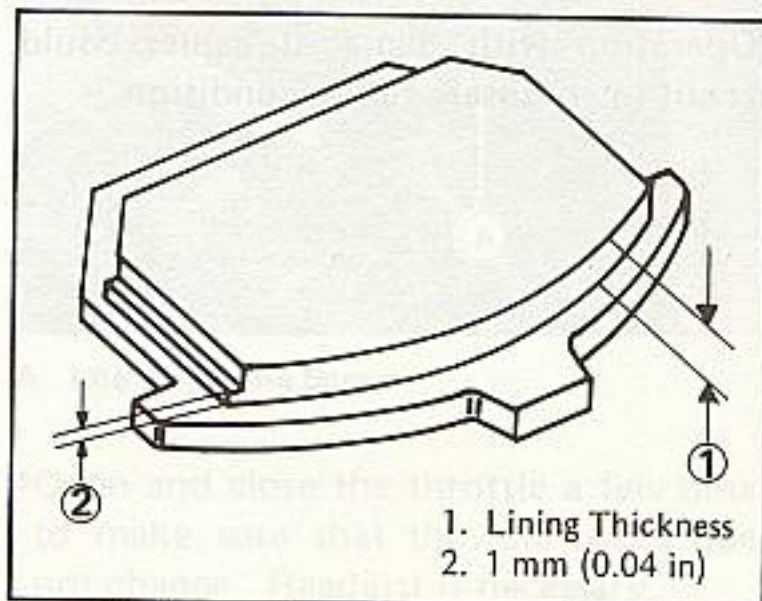

Disc Brake Fluid:

In accordance with the Periodic Maintenance Chart, inspect the brake fluid level in the reservoirs and change the brake fluid. The brake fluid should also be changed if it becomes contaminated with dirt or water.

Fluid Requirement

Recommended fluids are given in the table below. If none of the recommended brake fluids are available, use extra heavy-duty brake fluid only from a container marked D.O.T.4.

Recommended Disc Brake Fluid

Castrol Girling-Universal
Castrol GT (LMA)
Castrol Disc Brake Fluid
Check Shock Premium Heavy Duty

CAUTION

- Do not spill brake fluid onto any painted surface.
- Do not use fluid from a container that has been left open or that has been unsealed for a long time.
- Check for fluid leakage around the fittings.
- Check for brake hose damage.

Fluid Level Inspection

- The brake fluid level in the reservoir must be kept between the upper and lower level lines (reservoir held horizontal).

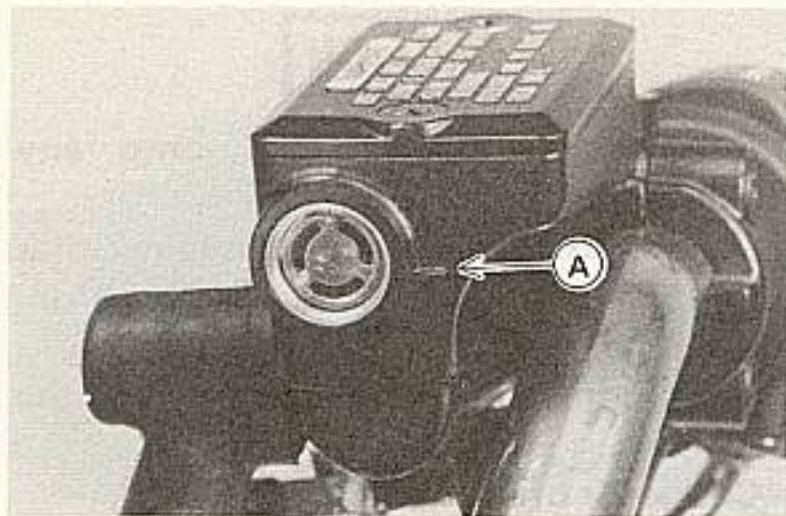

A. Lower Level

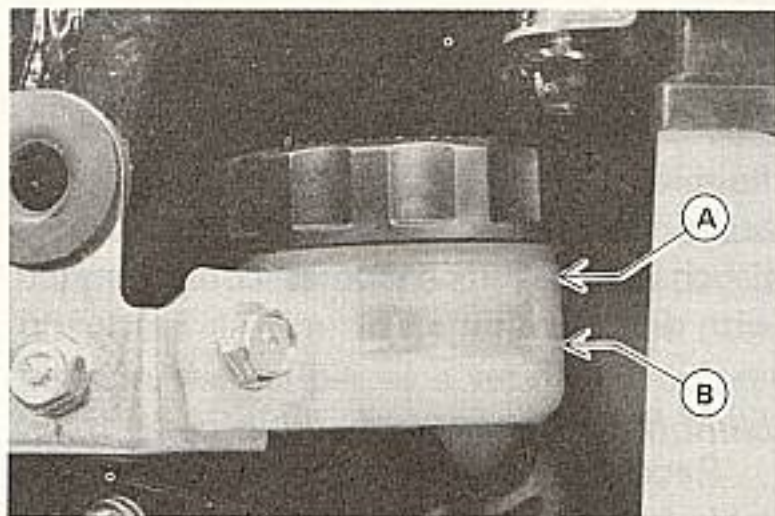

A. Upper Level B. Lower Level



A. Upper Level

- Fill the reservoir to the upper level line.

WARNING

- Do not mix two brands of fluid. Change the brake fluid in the brake line completely if the brake fluid must be refilled but the type and brand of the brake fluid that is already in the reservoir are unidentified.

Fluid Change

Have the brake fluid changed by an authorized Kawasaki Dealer.

Front and Rear Brakes:

Disc and disc pad wear is automatically compensated for and has no effect on the brake lever or pedal action. So there are no parts that require adjustment on the front and rear brakes.

WARNING

● If the brake lever or pedal feels mushy when it is applied, there might be air in the brake lines or the brake may be defective. Since it is dangerous to operate the motorcycle under such conditions, have the brake checked immediately by an authorized Kawasaki Dealer.

Brake Light Switches

When either the front or rear brake is applied, the brake light goes on. The front brake light switch requires no adjustment, but the rear brake light switch should be adjusted in accordance with the Periodic Maintenance Chart.

Inspection

- Turn on the ignition switch.
- The brake light should go on when the front brake is applied or the rear brake pedal is depressed by about 10 mm (0.4 in).
- If it does not, ask your authorized Kawasaki Dealer to inspect the front or rear brake light switch.

Front Fork

The condition of the front fork is very important for steering stability, and front fork performance is dependent on front fork oil viscosity, quantity, quality, and front fork air pressure.

Alteration of the stiffness or softness of the shock absorption can be achieved by using fork oil of a different viscosity or changing the fork air pressure. When altering the shock absorption by changing the fork air pressure, carry out the following steps:

- Put the motorcycle on its side stand.
- Take the air valve caps off the tops of the fork legs.
- The standard air pressure is atmospheric pressure.
- Pump air through the valve to raise the pressure.



A. Air Valve

NOTE

- A normal tire pump can be used.

CAUTION

- The maximum air pressure is 245 kPa (2.5 kg/cm², 36 psi). Higher pressure will damage the seals.

Rear Shock Absorbers

The rear shock absorbers can be adjusted by changing the air pressure and damping force to suit various riding and loading conditions.

Before making any adjustments, however, read the following procedures:

Air Pressure

The air pressure in the rear shock absorbers can be adjusted for different road and loading conditions.

The following table shows an example of air pressure adjustment. To obtain stable handling and a suitable ride, adjust the air pressure as indicated.

The standard air pressure for an average-build rider of 68 kg (150 lb) with no passenger and no accessories is atmospheric pressure. Ordinarily, the heavier the total load becomes, the higher the air pressure should be set.

Air Pressure Adjustment

Air Pressure	Setting	Load	Road
Atmospheric Pressure	Soft	Light	Good
↕	↕	↕	↕
196 kPa (2.0 kg/cm ² , 28 psi)	Hard	Heavy	Bad

To adjust the air pressure:

NOTE

- Check and adjust the air pressure when the rear shock absorbers are cold (room temperature).
- Put the motorcycle on its side stand.
- Take off the air valve caps on the left and right shock absorbers.

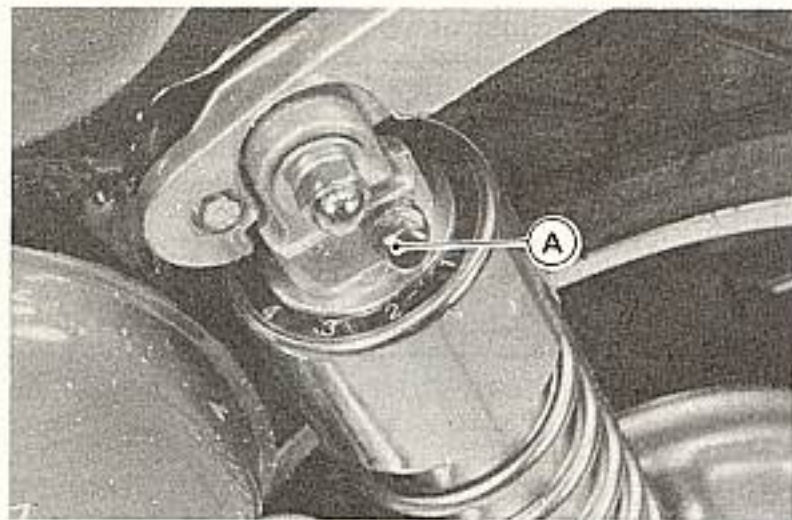

A. Air Valve

- Check the air pressure with the air pressure gauge.

NOTE

- *Do not use tire gauges for checking air pressure. They may not indicate the correct air pressure because of air leaks that occur when the gauge is applied to the valve.*

- To lower the air pressure, push the valve core in slightly. To raise the pressure, inject air through the valve with a tire pump. Change the air pressure within the range specified in the preceding table to suit various riding conditions.

CAUTION

- Inject air little by little so that air pressure does not rise rapidly. Air pressure exceeding 490 kPa (5.0 kg/cm², 71 psi) may damage the oil seal.
- Try to set the air pressure of the left and right shock absorbers as equally as possible.

WARNING

- Be sure to adjust the air pressure within the usable range. Pressure too high can produce a hazardous riding condition.

- Only air or nitrogen gas can be used. Never inject oxygen or any kind of explosive gas.
- Do not incinerate the rear shock absorbers.

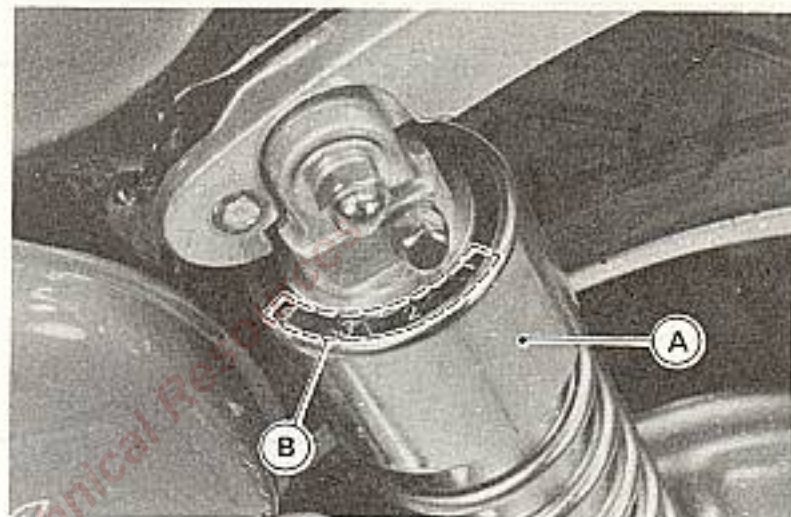

A. Damping Adjuster B. Number

Damping Force

The adjuster on each rear shock absorber has 4 positions so that the rebound damping force can be adjusted for different road and loading conditions. The numbers on the adjuster show the setting position.

The following table shows an example of damping force adjustment. To obtain stable handling and a suitable ride, adjust the damping force as indicated. The damping force can be left soft for average riding. But it should be adjusted harder for high speed riding or riding with a passenger. If the damping feels too soft or too stiff, adjust it in accordance with the following table:

Rebound Damping Adjustment

Adjuster Position	Damping Force	Setting	Load	Road	Speed
1	Stronger ↓	Soft	Light	Good	Low
2		↓ Hard	↓ Heavy	↓ Bad	↓ High
3					
4					

The standard setting position under the same conditions as in air pressure adjustment is No. 1.

To adjust the damping force:

- Turn the adjusters to the desired position until you feel a click.
- Check to see that both adjusters are turned to the same relative position.

WARNING

- If both damping adjusters are not adjusted equally, handling may be impaired and a hazardous condition may result.

Wheels

Tubeless tires are installed on the wheels of this motorcycle. The indications of **TUBELESS** on the tire side wall and the rim show that the tire and rim are specially designed for tubeless use.

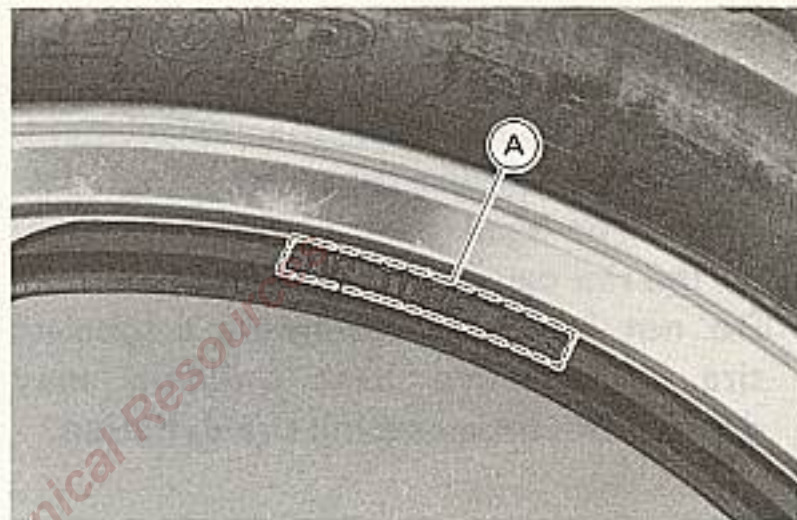

A. TUBELESS Mark

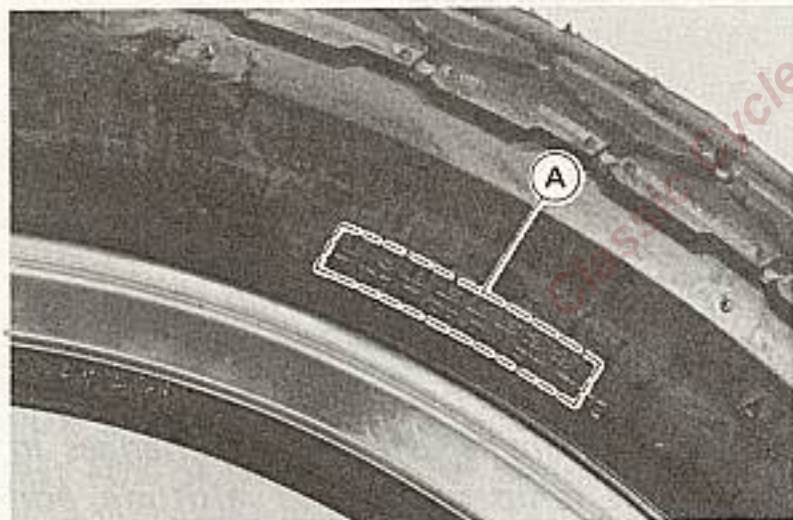

A. TUBELESS Mark

The tire and rim form a leakproof unit by making airtight contacts at the tire chafer and the rim flanges instead of using an inner tube.

WARNING

○The tires, rims, and air valves on this motorcycle are designed only for

tubeless type wheels. The recommended standard tires, rims, and air valves must be used for replacement.

- Do not install tube-type tires on tubeless rims. The beads may not seat properly on the rim causing tire deflation.
- Do not install a tube inside a tubeless tire. Excessive heat build-up may damage the tube causing tire deflation.

Tires:

Payload and Tire Pressure

Failure to maintain proper inflation pressures or observe payload limits for your tires may adversely affect handling and performance of your motorcycle and can result in loss of control. The maximum recommended load in addition to vehicle weight is 1,770 N (180 kg, 397 lb), including rider, passenger, baggage, and accessories.

- Check the tire pressure often, using an accurate gauge.

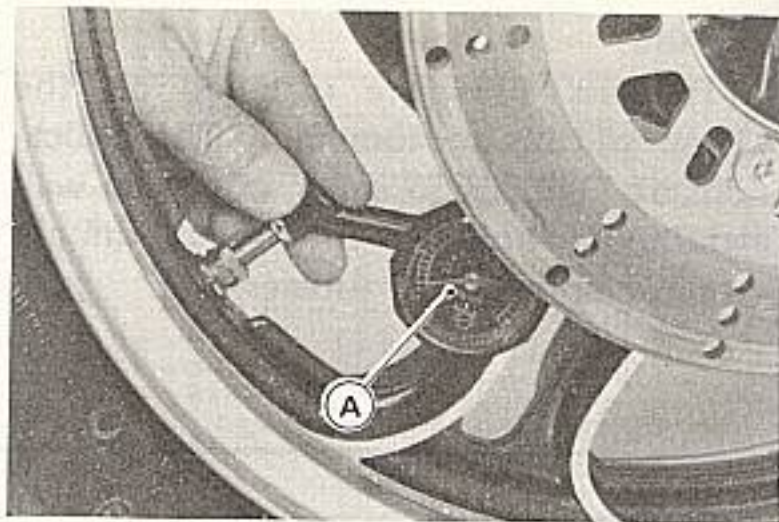

A. Tire Pressure Gauge

NOTE

- *Measure the tire pressure when the tires are cold (that is, when the motorcycle has not been ridden more than a mile during the past 3 hours).*
- *Tire pressure is affected by changes in ambient temperature and altitude, and so the tire pressure should be checked*

and adjusted when your riding involves wide variations in temperature or altitude.

Tire Air Pressure (when cold)

Front	225 kPa (2.25 kg/cm ² , 33 psi)
Rear	280 kPa (2.80 kg/cm ² , 40 psi)

Tire Wear, Damage

As the tire tread wears down, the tire becomes more susceptible to puncture and failure. An accepted estimate is that 90% of all tire failures occur during the last 10% of tread life (90% worn). So it is false economy and unsafe to use the tires until they are bald.

- In accordance with the Periodic Maintenance Chart, measure the depth of the tread with a depth gauge, and replace any tire that has worn down to the minimum allowable tread depth.

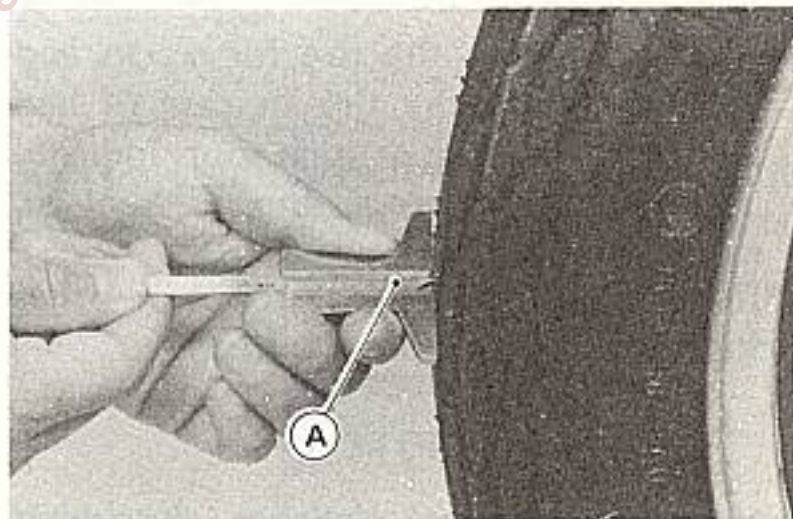

A. Tire Depth Gauge

Minimum Tread Depth

Front	1 mm (0.04 in)
Rear	2 mm (0.08 in)

- Visually inspect the tire for cracks and cuts, replacing the tire in case of bad damage. Swelling or high spots indicate internal damage, requiring tire replacement.
- Remove any imbedded stones or other foreign particles from the tread.

NOTE

- *Have the wheel balance inspected whenever a new tire is installed.*

WARNING

- To ensure safe handling and stability, use only the recommended standard tires for replacement, inflated to the standard pressure.
- Tires that have been punctured and repaired do not have the same capabilities as undamaged tires. Do not exceed 100 km/h (60 mph) within 24 hours after repair, and 180 km/h (110 mph) at any time after that.

Standard Tire

Front	100/90-18 56H DUNLOP F17 Tubeless
Rear	160/80-15 74H DUNLOP K425 Tubeless

Battery

Battery Electrolyte Level Inspection

The battery electrolyte level must be kept between the upper and lower level lines. Check the electrolyte level in each cell in accordance with the Periodic Maintenance Chart.

- Remove the battery from the motorcycle (See *Battery Removal*).
- Check that the electrolyte level in each cell is between the upper and lower level lines.



A. Filler Cap

B. Upper Level

C. Lower Level

- If the electrolyte level is low in any cell, fill with distilled water as follows.
- Remove the battery filler caps and fill with distilled water until the electrolyte level in each cell reaches the upper level line.

CAUTION

- Add only distilled water to the battery. Ordinary tap water is not a substitute

for distilled water and will shorten the life of the battery.

Battery Charging

- Remove the battery from the motorcycle (See *Battery Removal*).

CAUTION

- Always remove the battery from the motorcycle for charging. If the battery is charged while still installed, battery electrolyte may spill and corrode the frame or other parts of the motorcycle.
- Before charging, check the electrolyte level in each cell. If the electrolyte level is low in any cell, fill to above the lower level line but not up to the upper level line since the level rises during charging.
- Remove the caps from all the cells, and connect the battery charger leads to the battery terminals (red to +, black to -).

WARNING

- Because the battery gives off an explosive gas mixture of hydrogen and oxygen, keep any sparks or open flame away from the battery during charging. When using a battery charger, connect the battery to the charger before turning on the charger. This procedure prevents sparks at the battery terminals which could ignite any battery gases.

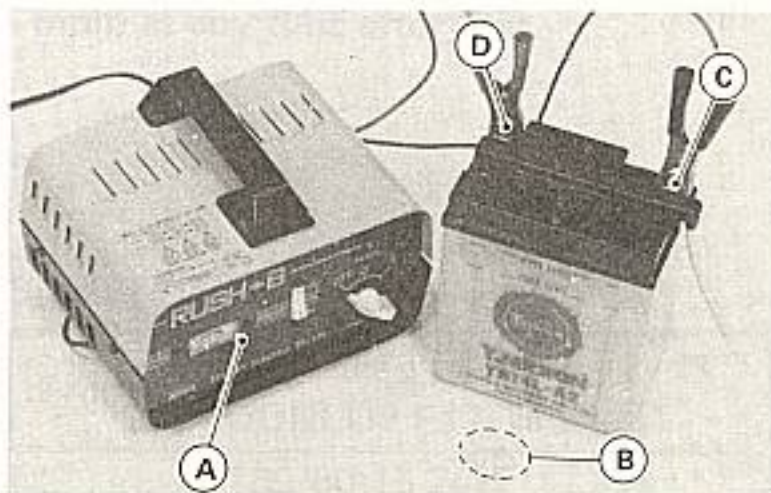

A. Battery Charger
B. Filler Caps

C. (-) Terminal
D. (+) Terminal

- Charge the battery at a rate that is 1/10th of the battery capacity. For example, the charging rate for a 10AH battery would be 1.0 ampere.

CAUTION

- Do not use a high rate battery charger, as is typically employed at automotive service stations, unless the charging rate can be reduced to the level required for motorcycle batteries. Charging the battery at a rate higher than specified may ruin the battery. Charging at a high rate causes excess heat which can warp the plates and cause internal shorting. Higher-than-normal charging rates also cause the plates to shed active material. Deposits will accumulate, and can cause internal shorting. If the temperature of the electrolyte rises above 45°C (115°F) during charging,

reduce the charging rate to lower the temperature, and increase charging time proportionately.

- After charging, check the electrolyte level in each cell. If the level has fallen, add distilled water to bring it back up to the upper level line.
- Install the caps on the cells.
- Install the battery.

Battery Removal

- Remove the right side cover.
- Unlock the seat and swing it up.
- Unscrew the battery holder.
- Remove the battery cover.

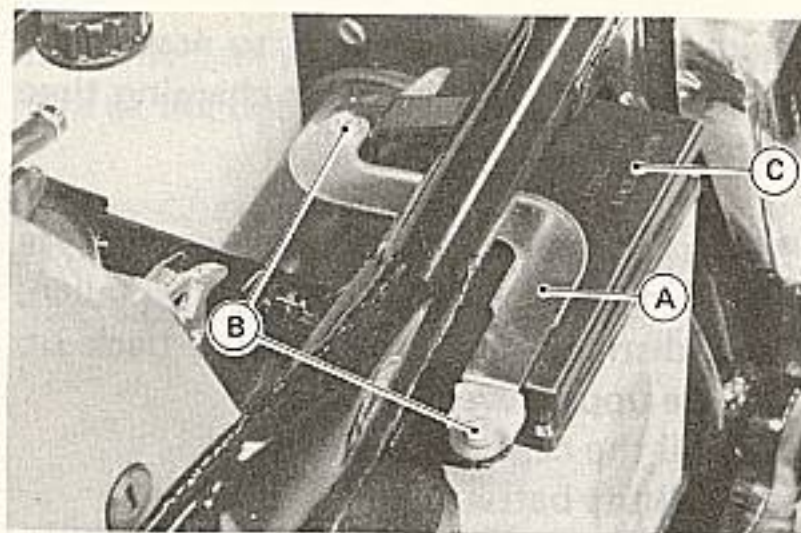

A. Battery Holder
B. Screw

C. Battery Cover

- Disconnect the leads from the battery, first from the (–) terminal and then the (+) terminal.

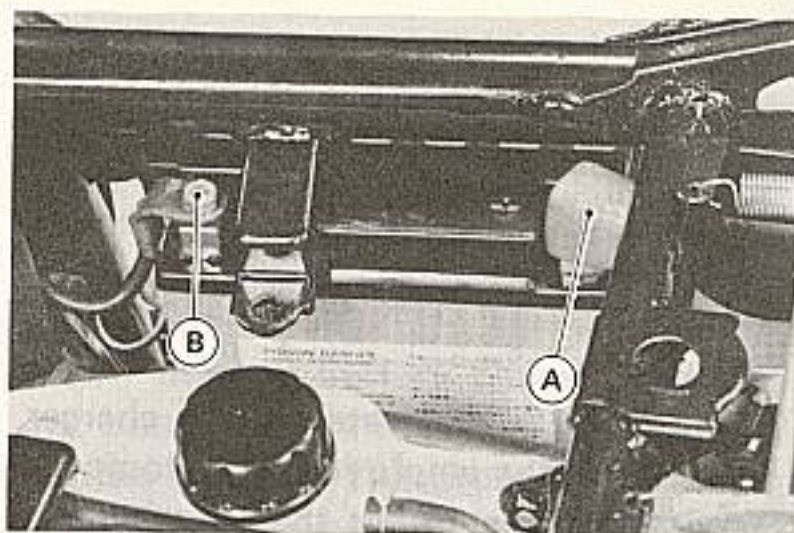

A. (+) Terminal

B. (–) Terminal

- Take the battery out of the case.
- Clean the battery using a solution of baking soda and water. Be sure that the lead connections are clean.

Battery Installation

- Put the battery in the battery case, and route the battery vent hose as shown on the caution label.
- Put a light coat of grease on the terminals to prevent corrosion.
- Connect the capped lead to the (+) terminal, and then connect the black lead to the (-) terminal.
- Cover the (+) terminal with its protective cap.

CAUTION

- Make sure the battery vent hose is kept away from the drive system and exhaust system. Battery electrolyte can corrode and dangerously weaken the drive system. Do not let the vent hose become folded, pinched, or melted by the exhaust system. An unvented battery will not keep a charge and it may crack from built-up gas pressure.

Headlight Beam

Horizontal Adjustment

The headlight beam is adjustable horizontally. If not properly adjusted horizontally, the beam will point to one side rather than straight ahead.

- Turn the adjusting screw on the headlight rim in or out until the beam points straight ahead.

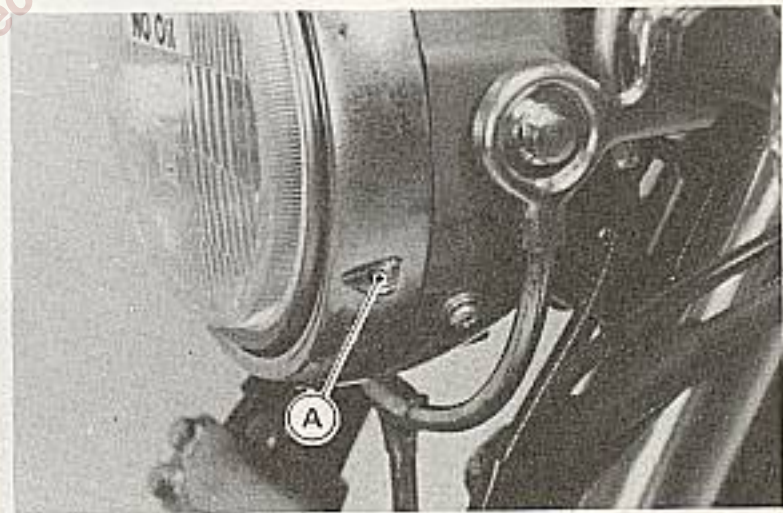

A. Adjusting Screw

Vertical Adjustment

The headlight beam is adjustable vertically. If adjusted too low, neither low nor high beam will illuminate the road far enough ahead. If adjusted too high, the high beam will fail to illuminate the road close ahead, and the low beam will blind oncoming drivers.

- Remove the mounting screws, and drop out the headlight unit.

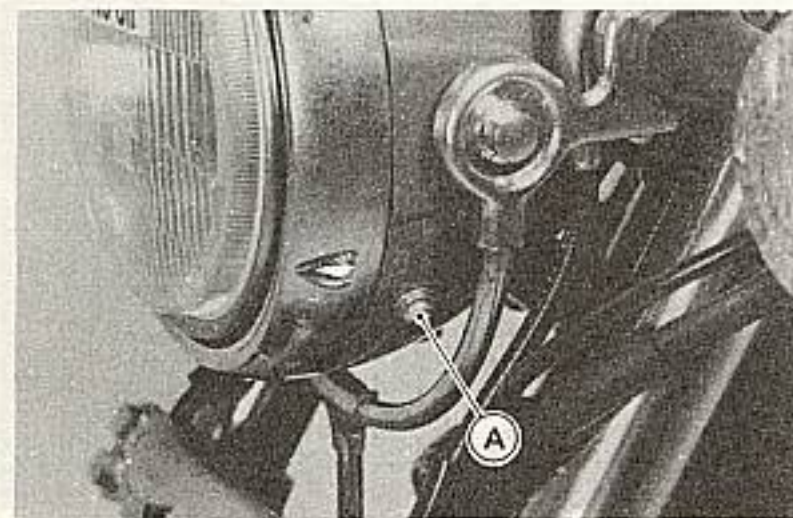

A. Mounting Screw

- Loosen the headlight housing mounting nuts, and adjust the headlight vertically.



A. Mounting Nut

- Tighten the headlight housing mounting nuts.
- Install the headlight unit, and tighten the mounting screws.

NOTE

- On high beam, the brightest point should be slightly below horizontal. The proper angle is 0.4 degrees below horizontal. This is a 50 mm (2 in) drop at 7.6 m (25 ft) measured from the center of the headlight, with the motorcycle on its wheels and the rider seated.

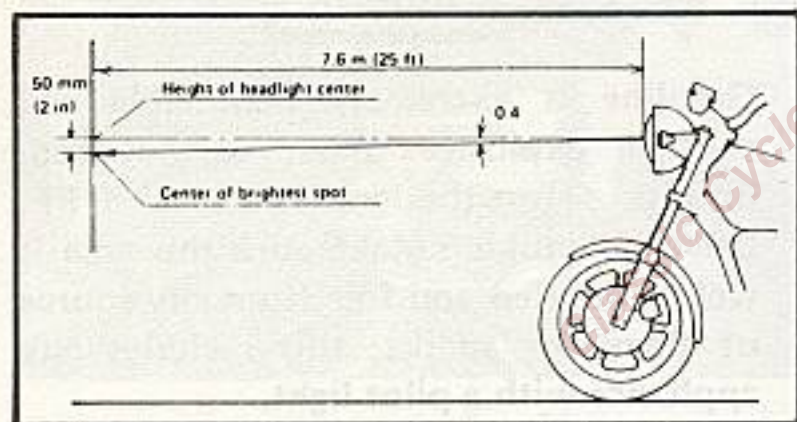

Fuses

Fuses are arranged in the junction box located inside the left side cover. If a fuse fails during operation, inspect the electrical system to determine the cause, and then replace it with a new fuse of proper amperage. Use the puller provided on the right of the junction box when checking and replacing blown fuses.

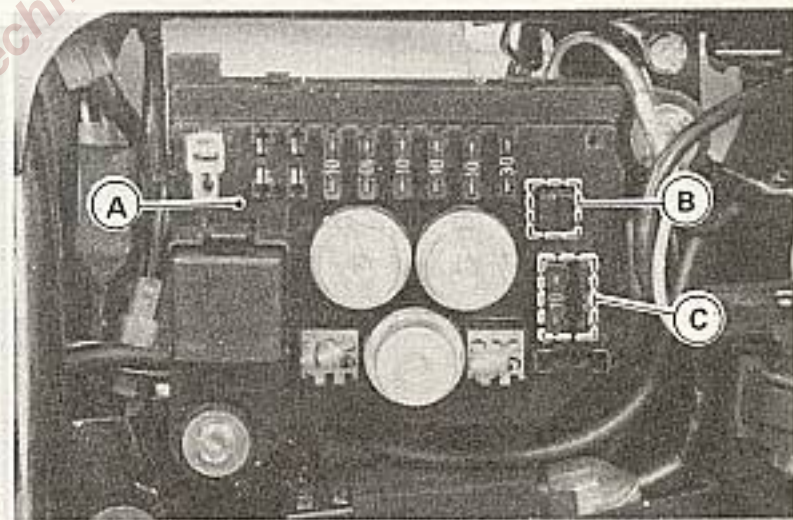

A. Junction Box
B. Puller

C. Spare Fuses

WARNING

- Do not use any substitute for the standard fuse.
- Replace the blown fuse with a new one of the correct capacity, as specified on the fuse case.

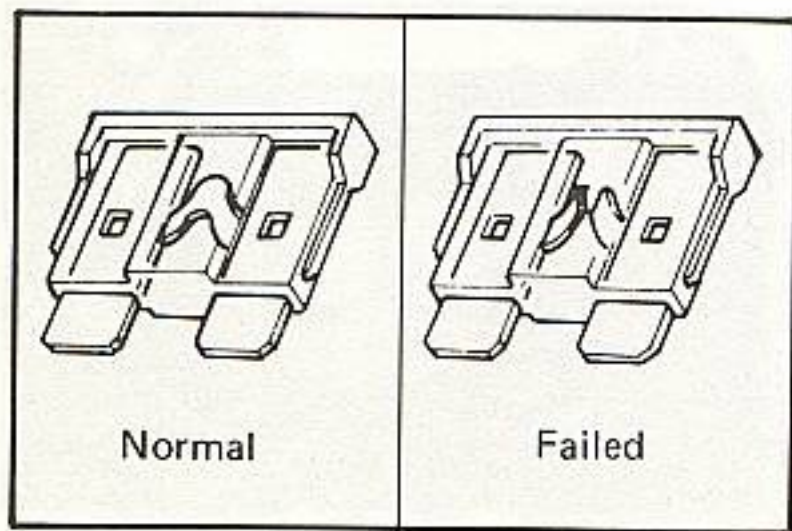

Fuel System

Accumulation of moisture or sediment in the fuel system will restrict the flow of fuel and cause carburetor malfunction. The system should be checked in accordance with the Periodic Maintenance Chart.

WARNING

- Gasoline is extremely flammable and can be explosive under certain conditions. Turn the ignition switch OFF. Do not smoke. Make sure the area is well ventilated and free from any source of flame or sparks; this includes any appliance with a pilot light.
- Make sure the engine is cold before working. Wipe any fuel off the engine before starting it.

Inspection

- Turn the fuel tap to the PRI position.
- Connect a suitable hose to the fitting at the bottom of each carburetor float bowl.

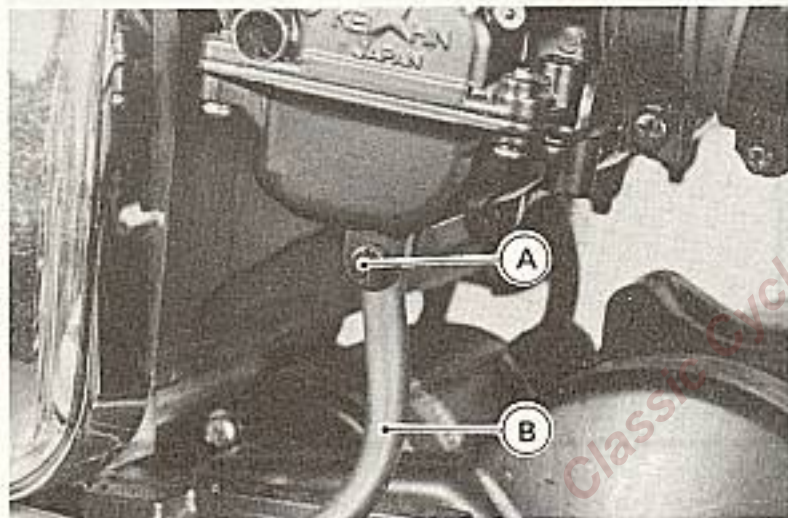

A. Drain Screw

B. Suitable Hose

- Run the lower ends of the hoses into a suitable container.
- Turn out each drain screw a few turns to drain the carburetors, and check to see if water or dirt has accumulated in the carburetors.
- Tighten the drain screws.

NOTE

- If any water or dirt appeared during the above operation, have the fuel system checked by a competent mechanic following the procedure in the Service Manual.

General Lubrication

Lubricate the points shown below, with either motor oil or regular grease, in accordance with the Periodic Maintenance Chart or whenever the vehicle has been operated under wet or rainy conditions.

Before lubricating each part, clean off any rusty spots with rust remover and wipe off any grease, oil, dirt, or grime.

NOTE

○A few drops of oil are effective to keep bolts and nuts from rusting and sticking. This makes removal easier. Badly rusted nuts, bolts, etc., should be replaced with new ones.

Apply Motor Oil to the following Pivots:

- Side Stand
- Clutch Lever
- Front Brake Lever

- Rear Brake Pedal
- Rear Brake Rod Joint

Soak the following Cables in Motor Oil:

- Throttle Inner Cable

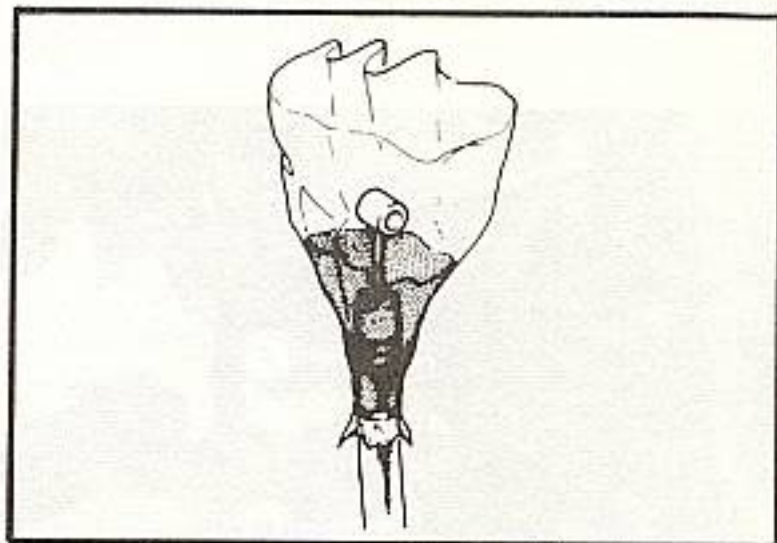

Apply Grease to the following Points:

- Throttle Inner Cable Upper End
- *○Speedometer Inner Cable
- *Grease the lower part of the inner cable sparingly.

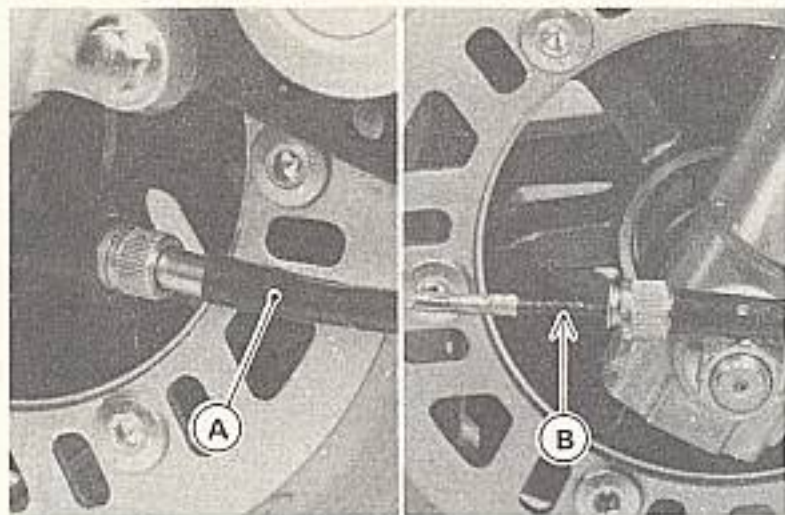

A. Speedometer Cable B. Grease

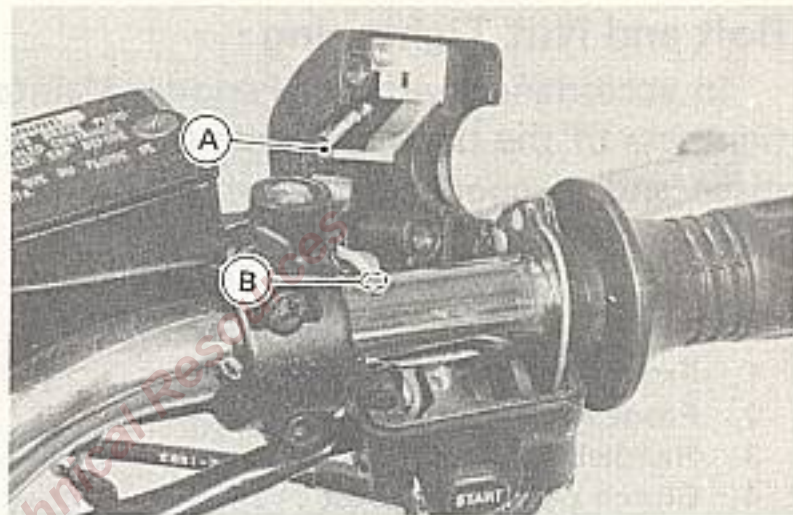

A. Projection B. Hole

NOTE

- After connecting the cables, adjust them.
- Making sure that the projection in the switch housing fits into the hole in the handlebar, assemble the switch housing. And after installing the switch housing, check the throttle grip play and adjust it if necessary.

- Insert the speedometer inner cable into the speedometer gear housing while turning the wheel so that the slot in the end of the cable will seat in the tongue of the speedometer pinion.

Bolt and Nut Tightening

In accordance with the Periodic Maintenance Chart, it is very important to check the tightness of the bolts and nuts listed here. Also, check to see that each cotter pin is in place and in good condition. Please ask your authorized Kawasaki Dealer for torque values.

1. Front Fender Mounting Bolts
2. Front Fork Clamp Bolts
3. Handlebar Clamp Bolts
4. Clutch Lever Pivot Bolt
5. Clutch Master Cylinder Clamp Bolts
6. Stem Head Bolt
7. Muffler Mounting Bolts and Nuts
8. Front Axle Nut
9. Caliper Mounting Bolts
10. Engine Mounting Bolts and Nuts
11. Side Stand Bolt
12. Shift Pedal Bolt
13. Footpeg Mounting Bracket Bolt
14. Pivot Shaft Nut
15. Final Gear Case Mounting Nuts
16. Rear Shock Absorber Mounting Nuts

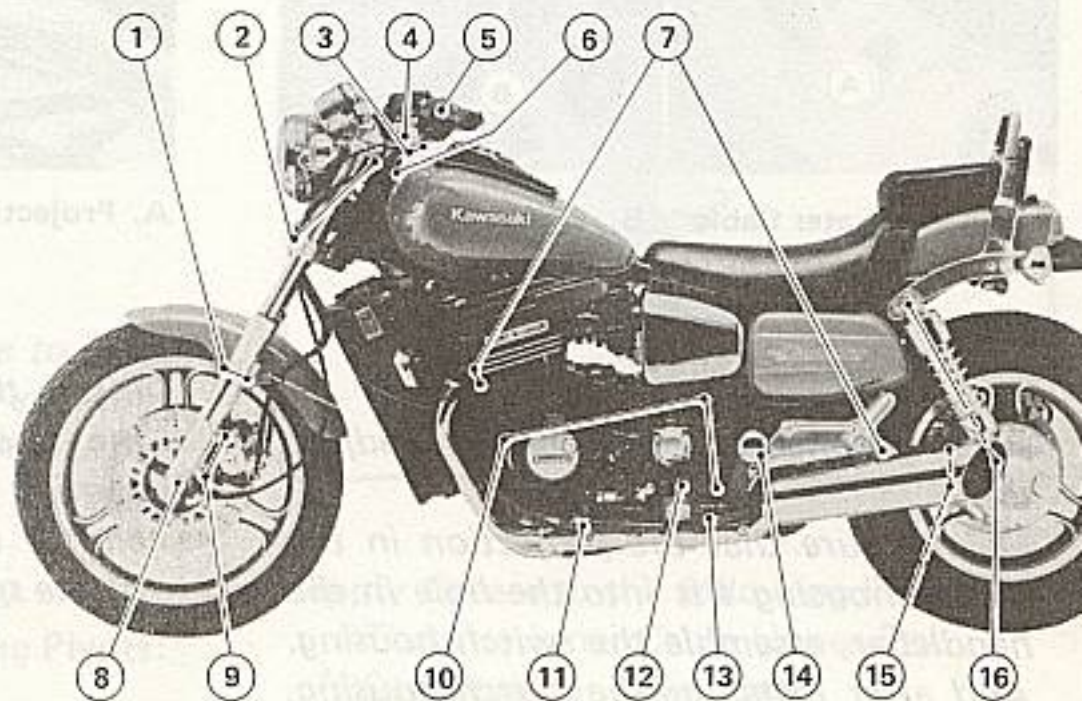

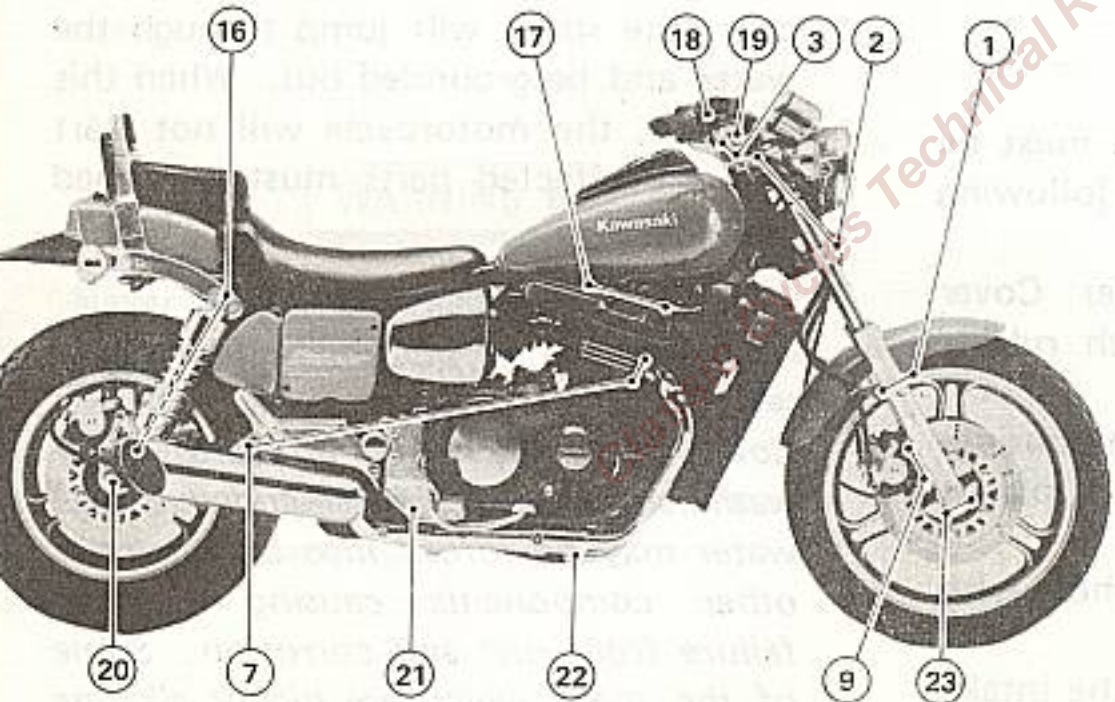

- 17. Cylinder Head Bolts
- 18. Brake Master Cylinder Clamp Bolts
- 19. Brake Lever Pivot Bolt
- 20. Rear Axle Nut
- 21. Brake Pedal Bolt
- 22. Muffler Connecting Pipe Clamp Bolts
- 23. Front Axle Clamp Bolt and Nut

Cleaning

For the prolonged life of your motorcycle, wash it down immediately after it has been splashed with seawater or exposed to the sea breeze; operated on rainy days, rough roads, or in dusty areas; or operated on roads on which salt has been scattered for ice removal.

Preparation for Washing

Before washing, precautions must be taken to keep water off the following places:

- Rear openings of each muffler; Cover with plastic bags secured with rubber bands.
- Clutch and brake levers, switch housings on the handlebar; Cover with plastic bags.
- Ignition switch; Cover the keyhole with tape.
- Air cleaner intake; Close up the intake with tape, or stuff with rags.

Where to be Careful

Avoid spraying water with any great force near the following places:

- Speedometer and tachometer
- Disc brake/clutch master cylinders and brake calipers.
- Under the fuel tank; If water gets into the ignition coils or into the spark plug caps, the spark will jump through the water and be grounded out. When this happens, the motorcycle will not start and the affected parts must be wiped dry.

NOTE

- Coin operated, high pressure spray washers are not recommended. The water may be forced into bearings and other components causing eventual failure from rust and corrosion. Some of the soaps which are highly alkaline leave a residue or cause spotting.*

After Washing

- Remove the plastic bags and tape, and clean the air cleaner intake.
- Lubricate the points listed in the General Lubrication section.
- Test the brakes before motorcycle operation.
- Start the engine and run it for 5 minutes.

WARNING

- Never wax or lubricate the brake discs. Loss of braking and an accident could result. Clean the disc with an oilless solvent such as trichloroethylene or acetone. Observe the solvent manufacturer's warnings.

STORAGE

Preparation for Storage:

- Clean the entire vehicle thoroughly.
- Empty the fuel from the fuel tank, and empty the carburetors by unscrewing the drain screw at each float bowl. (If left in for a long time, the fuel will break down and could clog the carburetors.)
- Remove the empty fuel tank, pour about 250 mL ($\frac{1}{2}$ pint) of motor oil into the tank, roll the tank around to coat the inner surfaces thoroughly, and pour out the excess oil.

WARNING

- Gasoline is extremely flammable and can be explosive under certain conditions. Turn the ignition switch OFF. Do not smoke. Make sure the area is well ventilated and free from any source of flame or sparks; this includes any appliance with a pilot light.
- Remove the spark plugs and put several drops of SE class SAE 30 oil into each cylinder. Push the starter button for a few seconds to coat the cylinder walls with oil, and install the spark plugs.
- Reduce tire pressure by about 20%.

- Set the motorcycle on a box or stand so that both wheels are raised off the ground. (If this cannot be done, put boards under the front and rear wheels to keep dampness away from the tire rubber.)
- Spray oil on all unpainted metal surfaces to prevent rusting. Avoid getting oil on rubber parts or in the brakes.
- Lubricate all the cables.
- Remove the battery, and store it where it will not be exposed to direct sunlight, moisture, or freezing temperatures. During storage it should be given a slow charge (one ampere or less) about once a month. Keep the battery well charged during cold weather so that the electrolyte does not freeze and crack open the battery. The more discharged the battery becomes, the more easily it freezes.
- Tie plastic bags over the exhaust pipes to prevent moisture from entering.
- Put a cover over the motorcycle to keep dust and dirt from collecting on it.

Preparation after Storage:

- Check the electrolyte level in the battery, charge the battery if necessary, and install it in the motorcycle. Be careful that the battery vent hose is not pinched and that it is kept away from the driving system and other frame parts.
- Make sure the spark plugs are tight.
- Fill the fuel tank with fuel.
- Change the engine oil.
- Check all the points listed in the Daily Safety Checks section.
- Lubricate the points listed in the General Lubrication section.

////////////////////// TROUBLESHOOTING GUIDE ////////////////////////

Engine Does Not Start:

Starter Motor Not Rotating

- Engine stop switch off
- Clutch lever not pulled in and transmission not in neutral
- Fuse blown
- Battery leads do not make good electrical contact with battery terminals
- Battery discharged

Engine Cranks Over But Does Not Start

- No fuel in tank
- Fuel line clogged
- Fuel broken down
- Choke is not used when engine is cold
- Engine flooded
- Spark plugs not in good contact
- Spark plugs fouled or wet
- Incorrect spark plug gap
- Incorrect valve clearance
- Battery discharged

Engine Stalls:

Just When Shifting Into 1st Gear

- Side stand has been left down
- Clutch does not properly disengage

While Riding

- Choke is used too long after moving off
- No fuel in tank
- Fuel tank air vent is obstructed
- Overheating
- Battery discharged

ADDITIONAL INFORMATION

Add the following to the Periodic Maintenance Chart.

Operation	Frequency	Whichever comes first ↓	*Odometer Reading							See Page
			800 (500)	5 000 (3 000)	10 000 (6 000)	15 000 (9 000)	20 000 (12 000)	25 000 (15 000)	30 000 (18 000)	
★Muffler connecting pipe clamp bolts and power chamber mounting bolts tightness—check †	Every		•	•	•	•	•	•	108	

K : Should be serviced by an authorized Kawasaki Dealer

* : For higher odometer readings, repeat at the frequency interval established here.

† : Replace, add, adjust, or torque if necessary.

(C): Californian model only

★ : Non-Emissions Related

Muffler

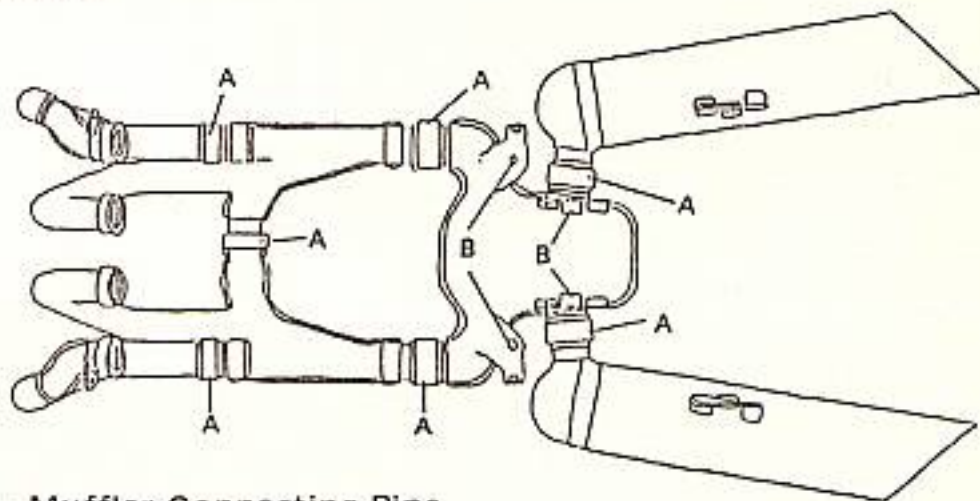

A. Muffler Connecting Pipe Clamp Bolt

KAWASAKI ZL900 PARTS & ACCESSORIES

Click on links below

[Kawasaki ZL900 Original Equipment Parts & Complete Online Diagrams](#)

[Kawasaki Eliminator Model History & Technical Specifications](#)

[Motorcycle Helmet Closeout Sale](#)

[Kawasaki Motorcycle Parts & Accessories](#)

[Kawasaki Dirt Bike Parts & Accessories](#)

[Save On All Motorcycle Tires](#)

[Motorcycle Gear Closeout Sale](#)

[High Visibility Motorcycle Gear](#)

[Cycle Gear – Free Shipping](#)

[Free Shipping On All Motorcycles](#)

[Discount Auto Parts – Free Shipping](#)

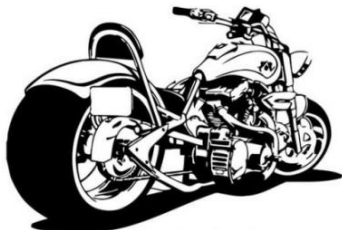

www.ClassicCycles.org